



INSTALLATION MANUAL

CTHC-24G

Passive Headend Combiner

IMPORTANT INFORMATION

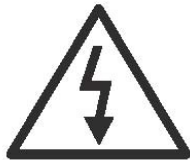

The lightning flash with arrowhead symbol, within an equilateral triangle, is intended to alert the user to the presence of uninsulated "dangerous voltage" within the product's enclosure that may be of sufficient magnitude to constitute a risk of electric shock to persons.



The exclamation point within an equilateral triangle is intended to alert the user to the presence of important operating and maintenance (servicing) instructions in the literature accompanying the appliance.

WARNING : TO REDUCE THE RISK OF FIRE OR ELECTRIC SHOCK, DO NOT EXPOSE THIS APPLIANCE TO RAIN OR MOISTURE. DO NOT OPEN THE CABINET, REFER SERVICING TO QUALIFIED PERSONNEL ONLY.

PACKAGE CONTENTS

This package contains:

- One CTHC-24G Passive Headend Combiner
- One CTHC-24G instruction manual

PRODUCT DESCRIPTION

The CTHC-24G is a professional quality 24-port passive output combiner designed for commercial grade, private cable networks employing multiple modulators and processing equipment. Quality design engineering and manufacturing are reflected in the CTHC-24G's port-to-port isolation figures as well as the unit's insertion loss specifications.

SPECIFICATIONS

CTHC-24G

24-Port Passive Headend Combiner Specifications (Typical)

RF	
1. Bandwidth	40 – 1000MHz
2. Input Number	24 ports
3. Impedance	75 Ohms
4. Insertion Loss	19 dB typical @ 40 – 450 MHz 21 dB typical @ 450 – 1000 MHz
5. Input Return Loss	16 dB typical @ 40 – 450 MHz 16 dB typical @ 450 – 1000 MHz
6. Output Return Loss	16 dB typical @ 40 – 450 MHz 16 dB typical @ 450 – 1000 MHz
7. Port-to-Port Isolation Adjacent Ports	30 dB typical
8. Port-to-Port Isolation Opposing Ports	40 dB typical
9. Test Port	-20 dB
GENERAL	
1. Operating Temperature	32 °F ~ 122 °F
2. Connectors	All "F" Type
MECHANICAL	
1. Dimensions	19" (W) x 1.75" (H) x 3" (D)
2. Weight	2 lb. 6 oz.

– INSTALLATION AND OPERATION

NOTE TO SYSTEM INSTALLER

System installer must adhere to Article 820-40 of the NEC that provides guidelines for proper grounding and specifies that the cable ground shall be connected to *the grounding system of the building*, as close to the point of cable entry as practical.

1. UNPACKING and HANDLING

Each unit is shipped with all equipment assembled, and factory tested.

Ensure that all accessories are removed from the container before discarding packing material

2. MECHANICAL INSPECTION

Inspect the front and rear of the equipment for shipping damage. Make sure the equipment is clean, and no connectors are broken, damaged, or loose. If equipment appears to be damaged or defective please contact us at 1-610-429-1511 for assistance.

3. PRODUCT DIAGRAM

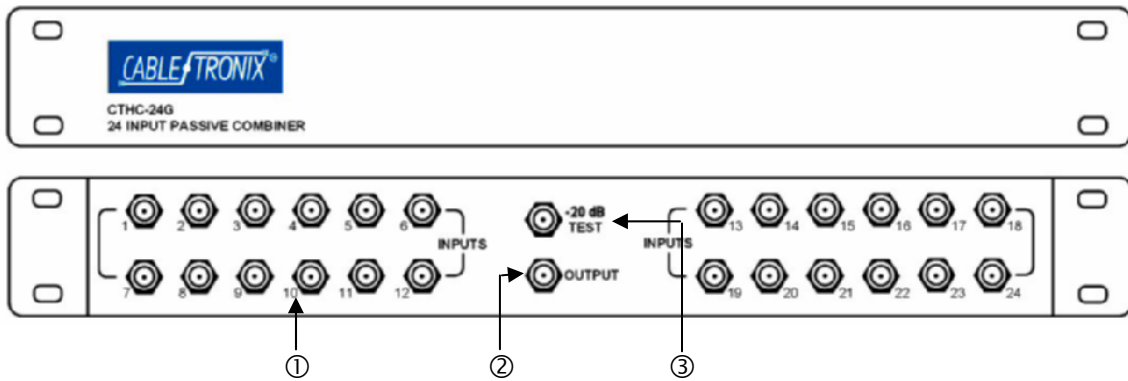

- | | | |
|---|------------------|--|
| 1 | Inputs | Source input RF signal from each channel is connected to these ports |
| 2 | Output | The combined RF channels are available at this port for connection to a launch or distribution amplifier |
| 3 | Test Port | -20dB output test port for system monitoring |

4. HARDWARE CONNECTIONS

- a. The CTHC-24G is designed for installation in a standard 19" EIA rack.
- b. Connect a 75ohm coaxial cable with F-connectors from each RF output source (generally the RF output port of a headend modulator) to the CTHC-24G Input port.
- c. Connect a 75ohm coaxial cable with F-connectors from the CTHC-24G's Output port to the input port of a headend launch amplifier such as the Cabletronix CTA-30RK/50 or to the main RF distribution network.
- d. Terminate the Test port with a Cabletronix F-59T terminator when not in use.
- e. The CTHC-24G consists of two rows of directional couplers combined with a hybrid splitter providing high isolation of 30 dB to 40 dB between the inputs. To further enhance adjacent channel isolation assign odd channels to one row of inputs and even channels to the other row of inputs.

5. ADJUSTMENT

The CTHC-24G is a passive device and does not require any adjustment. However, it is important that:

- a. The output levels of each modulator connected to the CTHC-24G are set consistent with the headend design specifications
- b. The combined output signal level from the CTHC-24G's Output port is consistent with the headend design specifications.

8. TROUBLESHOOTING

- a. Ensure you are using quality multiple shielded cables with quality radial or compression F-connectors.
- b. Ensure the F-connector's center conductor is making solid contact with the CTHC-24G's Input and Output ports, and the appropriate headend combiner and RF distribution network connectors.
- c. When taking measurements it is always best to use a quality signal level meter. System level measurements should be taken from the CTHC-24G's Output port. For field maintenance, the CTHC-24G's Test port may be used. However, note that port is padded down -20dB and the 20dB must be added back in when determining system level settings and output.
- d. Further troubleshooting assistance can be found on-line at www.northamericancable.com and www.cabletronix.com in addition to support from Cabletronix sales engineers at 1-610-429-1511.