



# ST-EZ32

# QUICK START GUIDE



# TABLE OF CONTENTS

<b>Chapter 1 Description of Panels .....</b>	<b>6</b>
1.1 Front Panel .....	6
1.2 Rear Panel .....	10
<b>Chapter 2 Installation and Connections .....</b>	<b>13</b>
2.1 NVR Installation.....	13
2.2 Hard Disk Installation.....	13
2.3 Connections.....	17
Wiring of Alarm Input.....	17
Wiring of Alarm Output .....	17
Using Alarm Connectors .....	18
Controller Connection.....	18
2.4 HDD Storage Calculation Chart .....	19
<b>Chapter 3 Menu Operation .....</b>	<b>20</b>
3.1 Menu Structure .....	20
3.2 Startup and Shutdown.....	20
3.3 Activating Your Device .....	21
3.4 Login and Logout .....	22
User Login .....	22
User Logout .....	23
3.5 Using the Setup Wizard.....	23
3.6 Network Settings .....	24
3.7 Adding IP Cameras.....	24
3.8 Live View .....	25
3.9 One-Touch RAID Configuration .....	26
3.10 Recording Settings.....	27
3.11 Playback .....	27
<b>Chapter 4 Remote Access.....</b>	<b>29</b>
4.1 Web Browser .....	29
4.2 Mobile Apps .....	30

## **Quick Start Guide**

### **About this Manual**

This Manual is applicable to Securitytronix EZII Network Video Recorders (NVR).

The Manual includes instructions for using and managing the product. Pictures, charts, images and all other information hereinafter are for description and explanation only. The information contained in the Manual is subject to change, without notice, due to firmware updates or other reasons.

Please use this user manual under the guidance of professionals to ensure a safe and proper deployment.

### **Legal Disclaimer**

THIS HARDWARE AND SOFTWARE IS PROVIDED BY SECURITYTRONIX "AS IS" AND ANY EXPRESS OR IMPLIED WARRANTIES, INCLUDING, BUT NOT LIMITED TO, THE IMPLIED WARRANTIES OF MERCHANTABILITY AND FITNESS FOR A PARTICULAR PURPOSE ARE DISCLAIMED. IN NO EVENT SHALL SECURITYTRONIX S BE LIABLE FOR ANY DIRECT, INDIRECT, INCIDENTAL, SPECIAL, EXEMPLARY, OR CONSEQUENTIAL DAMAGES (INCLUDING, BUT NOT LIMITED TO, PROCUREMENT OF SUBSTITUTE GOODS OR SERVICES; LOSS OF USE, DATA, OR PROFITS; OR BUSINESS INTERRUPTION) HOWEVER CAUSED AND ON ANY THEORY OF LIABILITY, WHETHER IN CONTRACT, STRICT LIABILITY, OR TORT (INCLUDING NEGLIGENCE OR OTHERWISE) ARISING IN ANY WAY OUT OF THE USE OF THIS HARDWARE AND SOFTWARE, EVEN IF ADVISED OF THE POSSIBILITY OF SUCH DAMAGE.

THE USE OF THE PRODUCT SHALL BE WHOLLY AT YOUR OWN RISK. SECURITYTRONIX SHALL NOT BE LIABLE FOR ANY ABNORMAL OPERATION, BREACH OF PRIVACY OR OTHER DAMAGES RESULTING FROM CYBER ATTACK, HACKER ATTACK, VIRUS INFECTION, OR OTHER INTERNET SECURITY RISKS. SURVEILLANCE LAWS VARY BY JURISDICTION. PLEASE CHECK ALL RELEVANT LAWS IN YOUR JURISDICTION BEFORE USING THIS PRODUCT IN ORDER TO ENSURE THAT USE CONFORMS TO ALL APPLICABLE LAWS. SECURITYTRONIX SHALL NOT BE LIABLE IN THE EVENT THAT THIS PRODUCT IS USED WITH ILLEGITIMATE PURPOSES.

**For further assistance, or if you encounter any issue while using this product, please contact your distributor or Securitytronix at: 800-688-9282 Press 3 for support, then 2 for CCTV.**

## Regulatory Information

### FCC Information

**FCC compliance:** This equipment has been tested and found to comply with the limits for a Class A digital device, pursuant to part 15 of the FCC Rules. These limits are designed to provide reasonable protection against harmful interference when the equipment is operated in a commercial environment. This equipment generates, uses, and can radiate radio frequency energy and, if not installed and used in accordance with the instruction manual, may cause harmful interference to radio communications. Operation of this equipment in a residential area is likely to cause harmful interference in which case the user will be required to correct the interference at his own expense.

### FCC Conditions

This device complies with part 15 of the FCC Rules. Operation is subject to the following two conditions:

1. This device may not cause harmful interference.
2. This device must accept any interference received, including interference that may cause undesired operation.

### EU Conformity Statement



This product and - if applicable - the supplied accessories too are marked with "CE" and comply therefore with the applicable harmonized European standards listed under the EMC Directive 2004/108/EC, the RoHS Directive 2011/65/EU.



2012/19/EU (WEEE directive): Products marked with this symbol cannot be disposed of as unsorted municipal waste in the European Union. For proper recycling, return this product to your local supplier upon the purchase of equivalent new equipment, or dispose of it at designated collection points. For more information see: [www.recyclethis.info](http://www.recyclethis.info)



2006/66/EC (battery directive): This product contains a battery that cannot be disposed of as unsorted municipal waste in the European Union. See the product documentation for specific battery information. The battery is marked with this symbol, which may include lettering to indicate cadmium (Cd), lead (Pb), or mercury (Hg). For proper recycling, return the battery to your supplier or to a designated collection point. For more information see: [www.recyclethis.info](http://www.recyclethis.info)

### Industry Canada ICES-003 Compliance

This device meets the CAN ICES-3 (A)/NMB-3(A) standards requirements.



## Safety Instruction

These instructions are intended to ensure that user can use the product correctly to avoid danger or property loss.

The precaution measure is divided into “Warnings” and “Cautions”

**Warnings:** Serious injury or death may occur if any of the warnings are neglected.

**Cautions:** Injury or equipment damage may occur if any of the cautions are neglected.

	
<b>Warnings</b> Follow these safeguards to prevent serious injury or death.	<b>Cautions</b> Follow these precautions to prevent potential injury or material damage.



### Warnings

- Proper configuration of all passwords and other security settings is the responsibility of the installer and/or end-user.
- While using this product, you must be in strict compliance with the electrical safety regulations of the nation and region. Please refer to technical specifications for detailed information.
- Input voltage should meet both the SELV (Safety Extra Low Voltage) and the Limited Power Source with 100~240 VAC or 12 VDC according to the IEC60950-1 standard. Please refer to technical specifications for detailed information.
- Do not connect several devices to one power adapter as adapter overload may cause over-heating or a fire hazard.
- Please make sure that the plug is firmly connected to the power socket.
- If smoke, odor or noise rise from the device, turn off the power at once and unplug the power cable, and then please contact technical support.



## Preventive and Cautionary Tips

Before connecting and operating your device, please be advised of the following tips:

- Ensure the unit is installed in a well-ventilated, dust-free environment.
- Unit is designed for indoor use only.
- Keep all liquids away from the device.
- Ensure environmental conditions meet factory specifications.
- Ensure unit is properly secured to a rack or shelf. Major shocks or jolts to the unit as a result of dropping it may cause damage to the sensitive electronics within the unit.
- Use the device in conjunction with a UPS if possible.
- Power down the unit before connecting and disconnecting accessories and peripherals.
- Surveillance grade HDDs should be used with this recorder.
- Improper use or replacement of the battery may result fire or explosion hazard. Replace with the same or equivalent type only. Dispose of used batteries according to the instructions provided by the battery manufacturer.

## Symbol Conventions

The symbols that may be found in this document are defined as follows.

Symbol	Description
	Indicates a potentially hazardous situation, which if not avoided, could result in equipment damage, data loss, performance degradation, or unexpected results.
	Provides additional information to emphasize or supplement important points of the main text.

# Chapter1 Description of Panels

## 1.1 Front Panel

### Front Panel 1

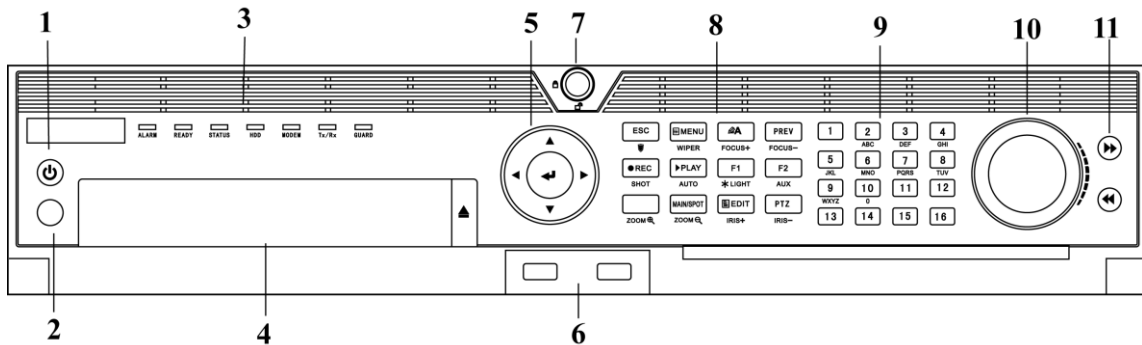

Figure 1. 1 Front Panel

Table 1. 1 Description of Interfaces

No.	Name	Function Description	
1	<b>POWER ON/OFF</b>	Power on/off switch.	
2	<b>IR Receiver</b>	Receiver for IR remote	
3	<b>Status Indicators</b>	<b>ALARM</b>	Turns red when a sensor alarm is detected.
		<b>READY</b>	Ready LED is normally blue, indicating that the device is functioning properly.
		<b>STATUS</b>	Turns blue when device is controlled by an IR remote.
			Turns red when controlled by a keyboard and purple when IR remote and keyboard is used at the same time.
		<b>HDD</b>	Flashes red when data is being read from or written to HDD.
		<b>MODEM</b>	Reserved for future usage.
		<b>TX/RX</b>	Flashes blue when network connection is functioning properly.
<b>GUARD</b>	Guard LED turns blue when the device is in armed status; at this time, an alarm is enabled when an event is detected.		
	The LED turns off when the device is unarmed. The arm/disarm status can be changed by pressing and holding on the ESC button for more than 3 seconds in live view mode.		
4	<b>DVD-R/W</b>	Slot for DVD-R/W.	
5	<b>Control Buttons</b>	<b>DIRECTION</b>	The DIRECTION buttons are used to navigate between different fields and items in menus.
			In the Playback mode, the Up and Down button is used to speed up and slow down recorded video. The Left and Right button

No.	Name	Function Description	
		will select the next and previous record files.	
		In Live View mode, these buttons can be used to cycle through channels.	
		In PTZ control mode, it can control the movement of the PTZ camera.	
		<b>ENTER</b>	The ENTER button is used to confirm selection in any of the menu modes.
			It can also be used to <i>tick</i> checkbox fields.
			In Playback mode, it can be used to play or pause the video.
			In single-frame Playback mode, pressing the button will advance the video by a single frame.
In Auto-switch mode, it can be used to stop /start auto switch.			
6	<b>USB Interfaces</b>	Universal Serial Bus (USB) ports for additional devices such as USB mouse and USB Hard Disk Drive (HDD).	
7	<b>Front Panel Lock</b>	You can lock or unlock the panel by the key.	
8	<b>Composite Keys</b>	<b>ESC</b>	Back to the previous menu.
			Press for Arming/disarming the device in Live View mode.
		<b>REC/SHOT</b>	Enter the Manual Record setting menu.
			In PTZ control settings, press the button and then you can call a PTZ preset by pressing Numeric button.
			It is also used to turn audio on/off in the Playback mode.
		<b>PLAY/AUTO</b>	The button is used to enter the Playback mode.
			It is also used to auto scan in the PTZ Control menu.
		<b>ZOOM+</b>	Zoom in the PTZ camera in the PTZ Control setting.
		<b>A/FOCUS+</b>	Adjust focus in the PTZ Control menu.
			It is also used to switch between input methods (upper and lowercase alphabet, symbols and numeric input).
		<b>EDIT/IRIS+</b>	Edit text fields. When editing text fields, it will also function as a Backspace button to delete the character in front of the cursor.
			On checkbox fields, pressing the button will <i>tick</i> the checkbox.
			In PTZ Control mode, the button adjusts the iris of the camera.
			In Playback mode, it can be used to generate video clips for backup.
		<b>MAIN/SPOT/ZOOM-</b>	Enter/exit the folder of USB device and eSATA HDD.
			Switch between main and spot output.
		<b>F1/ LIGHT</b>	In PTZ Control mode, it can be used to zoom out the image.
			Select all items on the list when used in a list field.
			In PTZ Control mode, it will turn on/off PTZ light (if applicable).
		<b>F2/ AUX</b>	In Playback mode, it is used to switch between play and reverse play.
Cycle through tab pages.			
<b>MENU/WIPER</b>	In synchronous playback mode, it is used to switch between channels.		
	Press the button will help you return to the Main menu (after successful login).		

No.	Name	Function Description
		Press and hold the button for 5 seconds will turn off audible key beep.
		In PTZ Control mode, the MENU/WIPER button will start wiper (if applicable).
		In Playback mode, it is used to show/hide the control interface.
	<b>PREV/FOCUS-</b>	Switch between single screen and multi-screen mode.
		In PTZ Control mode, it is used to adjust the focus in conjunction with the A/FOCUS+ button.
	<b>PTZ/IRIS-</b>	Enter the PTZ Control mode.
In the PTZ Control mode, it is used to adjust the iris of the PTZ camera.		
9	<b>Alphanumeric Buttons</b>	Switch to the corresponding channel in Live view or PTZ Control mode.
		Input numbers and characters in Edit mode.
		Switch between different channels in Playback mode.
		The light of the button is blue when the corresponding channel is recording; it is red when the channel is in network transmission status; it is pink when the channel is recording and transmitting.
10	<b>JOG SHUTTLE Control</b>	Moves the active selection up and down in a menu.
		Cycles through different channels in live view mode.
		Jumps 30s forward/backward in video files in the playback mode.
		Controls the movement of the PTZ camera in PTZ control mode
11	<b>SLOW DOWN/SPEED UP</b>	Slow down/speed up in playback mode.

## Front Panel 2

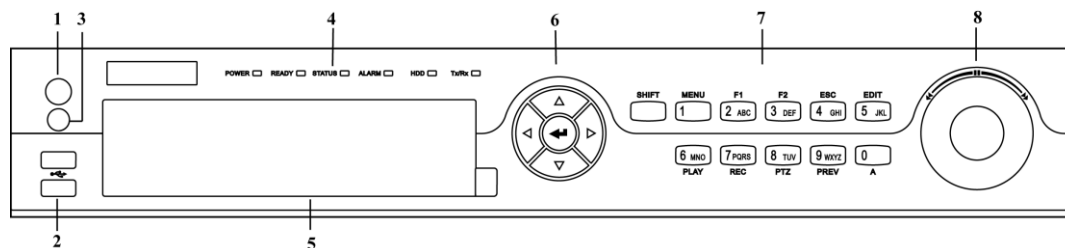

Figure 1. 2 Front Panel

Table 1. 2 Description of Front Panel

No.	Name	Function Description
1	<b>POWER ON/OFF</b>	Power on/off switch.
2	<b>USB Interface</b>	Connect to USB mouse or USB flash memory.
3	<b>IR Receiver</b>	Receiver for IR remote control. devices.
4	<b>POWER</b>	Power indicator lights green when the DVR is powered up.

	<b>READY</b>	Ready indicator is normally green, indicating that the DVR is functioning properly.
	<b>STATUS</b>	Indicator turns green when DVR is controlled by an IR remote control with the address from 1~254; Indicator turns red when the SHIFT button is used; Indicator does not light when the DVR is controlled by a keyboard or by the IR remote control with the address of 255; Indicator turns green when the DVR is controlled by IR remote control (with the address from 1~254) and keyboard at the same time , and the SHIFT button is not used; Indicator turns orange : (a) when the DVR is controlled by IR remote control (with the address from 1~254) and keyboard at the same time and the SHIFT button is used as well; (b) when the DVR is controlled by IR remote control (with the address from 1~254) and the SHIFT button is used.
	<b>ALARM</b>	Alarm indicator turns red when a sensor alarm is detected.
	<b>HDD</b>	HDD indicator blinks red when data is being read from or written to the HDD.
	<b>Tx/Rx</b>	TX/RX indicator blinks in green when network connection is functioning properly.
<b>5</b>	<b>DVD-ROM</b>	Slot for DVD-ROM.
<b>6</b>	<b>DIRECTION</b>	The DIRECTION buttons are used to navigate between different fields and items in menus. In Playback mode, the Up and Down button is used to speed up and slow down recorded video. In All-day Playback mode, the Left/Right button can be used to select the recorded video of next/previous day; in Playback by Normal Video Search, the Left/Right button can be used to select the next/previous recorded file. In Live View mode, the directional buttons can be used to cycle through channels. In PTZ control mode, it can control the movement of the PTZ camera.
	<b>ENTER</b>	Confirm selection in any of the menu modes. It can also be used to tick checkbox fields. In Playback mode, it can be used to play or pause the video. In Single-frame Playback mode, pressing the ENTER button will advance the video by a single frame. In Auto-switch mode, it can be used to stop /start auto switch.
<b>7</b>	<b>SHIFT</b>	Switch of compound keys between the numeric/letter input and functional control.
	<b>1/MENU</b>	Enter numeral "1"; Access the main menu interface.
	<b>2ABC/F1</b>	Enter numeral "2"; Enter letters "ABC"; The F1 button can be used to select all items on the list; In PTZ Control mode, the F1 button can be used to zoom out (zoom-) the PTZ camera; In live view or playback mode, the F1 button can be used to switch between main and spot video output.
	<b>3DEF/F2</b>	Enter numeral "3"; Enter letters "DEF"; In PTZ Control mode, the F1 button can be used to zoom in (zoom+) the PTZ camera; The F2 button can be used to cycle through tab pages.
	<b>4GHI/ESC</b>	Enter numeral "4"; Enter letters "GHI"; Exit and back to the previous menu.
	<b>5JKL/EDIT</b>	Enter numeral "5"; Enter letters "JKL"; Delete characters before cursor; Select the checkbox and ON/OFF switch; Start/stop record clipping in playback.
	<b>6MNO/PLAY</b>	Enter numeral "6"; Enter letters "MNO"; In Playback mode, it is used for direct access to playback interface.
	<b>7PQRS/REC</b>	Enter numeral "7"; Enter letters "PQRS"; Manual record, for direct access to manual record interface; manually enable/disable record.
	<b>8TUV/PTZ</b>	Enter numeral "8";

		Enter letters “TUV”; Access PTZ control interface.
	<b>9WXYZ/PREV</b>	Enter numeral “9”; Enter letters “WXYZ”; Multi-camera display in live view; In Playback mode or Menu→Playback→Tag playback interface, this button can be used to delete the selected tag.
	<b>0/A</b>	Enter numeral “0”; Switch between input methods (upper and lowercase alphabet, symbols and numeric input). In Playback mode, this button can be used to add the default tag.
<b>8</b>	<b>JOG SHUTTLE Control</b>	Move the active selection in a menu. The inner ring will move the selection up and down; the outer ring will move it left and right. In Playback mode, the inner ring is used to jump 30s forward/backward in video files. The outer ring can be used to speed up/slow down the video. In Live View mode, it can be used to cycle through different channels. In PTZ control mode, it can control the movement of the PTZ camera.

## 1.2 Rear Panel

### Rear Panel 1

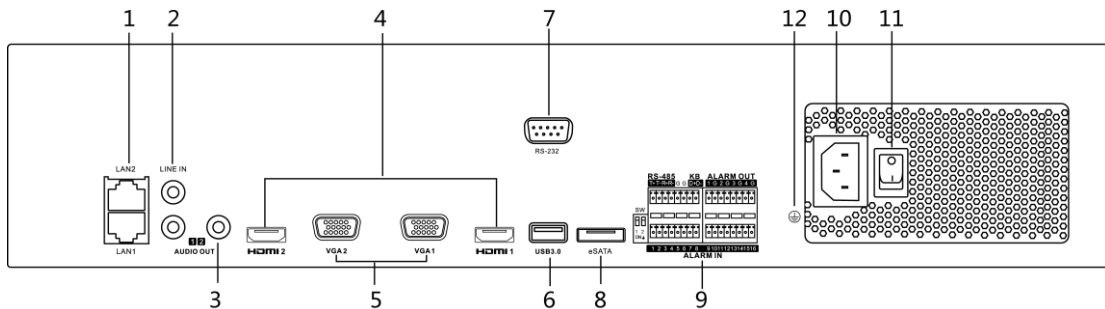

Figure 1. 3 Rear Panel

Table 1. 3 Description of Interfaces

No.	Item	Description
1	<b>LAN1/LAN2 Interface</b>	2 RJ-45 10/100/1000 Mbps self-adaptive Ethernet interfaces provided.
2	<b>LINE IN</b>	RCA connector for audio input.
3	<b>AUDIO OUT</b>	2 RCA connectors for audio output.
4	<b>HDMI1/HDMI2</b>	HDMI video output connector.
5	<b>VGA1/VGA2</b>	DB9 connector for VGA output. Display local video output and menu.
6	<b>USB 3.0 interface</b>	Universal Serial Bus (USB) ports for additional devices such as USB mouse and USB Hard Disk Drive (HDD).
7	<b>RS-232 Interface</b>	Connector for RS-232 devices.
8	<b>eSATA</b>	Connects external SATA HDD, CD/DVD-RM.
9	<b>Controller Port</b>	D+, D- pin connects to Ta, Tb pin of controller. For cascading devices, the first NVR's D+, D- pin should be connected with the D+, D- pin of the next NVR.

No.	Item	Description
	<b>ALARM IN</b>	Connector for alarm input.
	<b>ALARM OUT</b>	Connector for alarm output.
<b>10</b>	<b>AC 100V ~ 240V</b>	100 to 240 VAC power supply.
<b>11</b>	<b>Power Switch</b>	Switch for turning on/off the device.
<b>12</b>	<b>GROUND</b>	Ground (needs to be connected when NVR starts up).

## Rear Panel 2

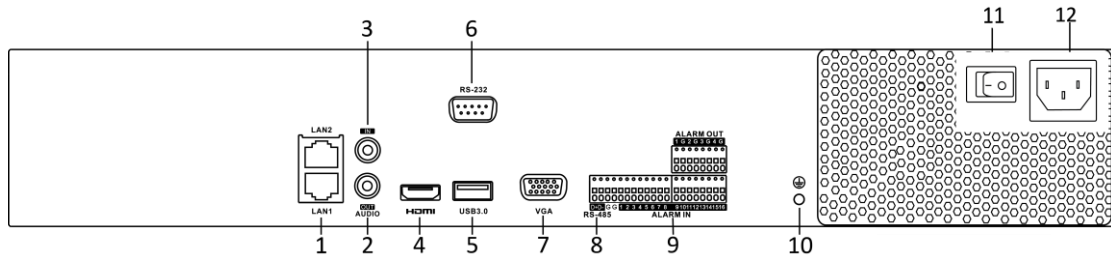

Figure 1. 4 Without POE Interface Series

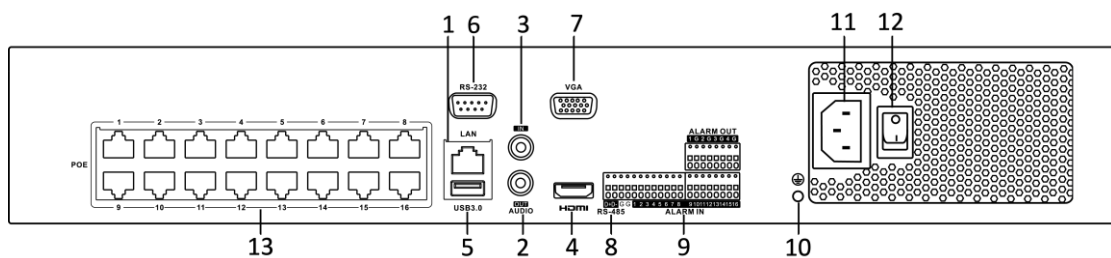

Figure 1. 5 With POE Interface Series

Table 1. 4 Description of Rear Panel Interfaces

No.	Item	Description
1	LAN Interface	1 network interface provided for POE Series and 2 network interfaces for non POE series.
2	AUDIO OUT	RCA connector for audio output.
3	LINE IN	RCA connector for audio input.
4	HDMI	HDMI video output connector.
5	USB 3.0 interface	Universal Serial Bus (USB) ports for additional devices such as USB mouse and USB Hard Disk Drive (HDD).
6	RS-232 Interface	Connector for RS-232 devices.
7	VGA	DB9 connector for VGA output. Display local video output and menu.
8	RS-485 Interface	Half-duplex connector for RS-485 devices.
9	ALARM IN	Connector for alarm input.
	ALARM OUT	Connector for alarm output.
10	GROUND	Ground (needs to be connected when NVR starts up).
11	AC 100V ~ 240V	100V ~ 240VAC power supply.
12	Power Switch	Switch for turning on/off the device.
13	Network Interfaces with PoE function	Network interfaces for the cameras and to provide power over Ethernet.

## Chapter 2 Installation and Connections

### 2.1 NVR Installation

During installation of the NVR:

1. Use brackets for rack mounting.
2. Ensure ample room for audio and video cables.
3. When routing cables, ensure that the bend radius of the cables are no less than five times than its diameter.
4. Connect the alarm cable.
5. Allow at least 2cm ( $\approx 0.75$ -inch) of space between rack mounted devices.
6. Ensure the NVR is grounded.
7. Environmental temperature should be within the range of 14 F ~ 131 F.
8. Environmental humidity should be within the range of 10% ~ 90%.

### 2.2 Hard Disk Installation

*Before you start:*

Disconnect the power from the NVR before installing a hard disk drive (HDD). A factory recommended HDD should be used for this installation. Up to eight SATA hard disks can be installed.



As the installation steps of HDD are similar among different models, here we take the steps of certain series as examples.

**Tools Required:** Screwdriver.

#### **HDD Installation (A)**

*Steps:*

1. Remove the NVR cover by unfastening the screws on the back and side.



Figure 2. 1 Remove the Cover

2. Install the HDD in the HDD rack using the provided screws. Fasten the screws on the button to fix the HDD.

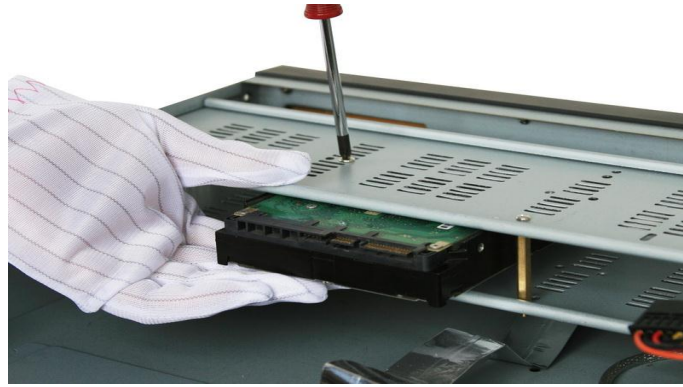

Figure 2. 2 Install the HDD

- 
3. Connect one end of the data cable to the NVR motherboard and the other end to the HDD.

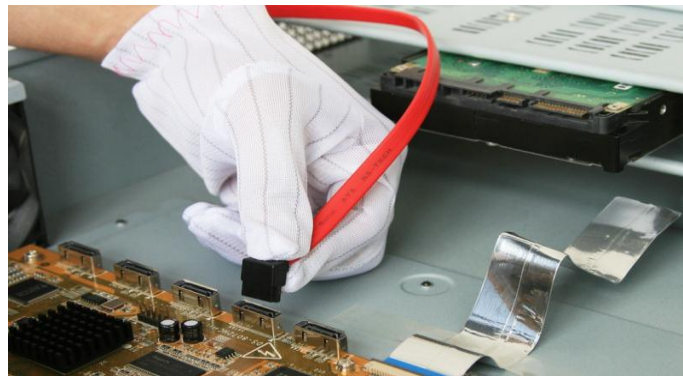

Figure 2. 3 Connect the data cable

- 
4. Connect the power cable to the HDD.

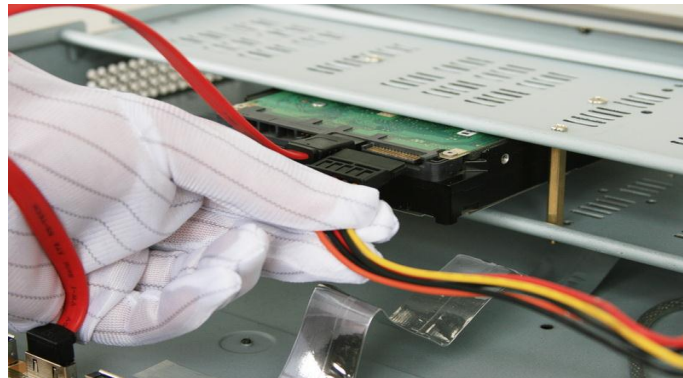

Figure 2. 4 Connect the power cable

---

### **HDD Installation (B)**

*Steps:*

1. Fasten the hard disk mounting handle to the hard disk with screws.



2. Insert the key and turn in clockwise direction to open the panel lock.

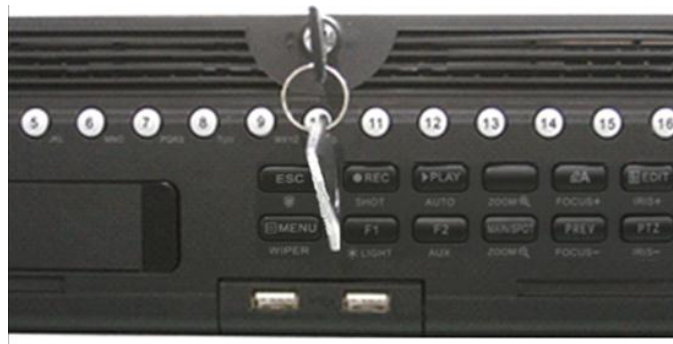

3. Press the buttons on the panel of two sides and open the front panel.

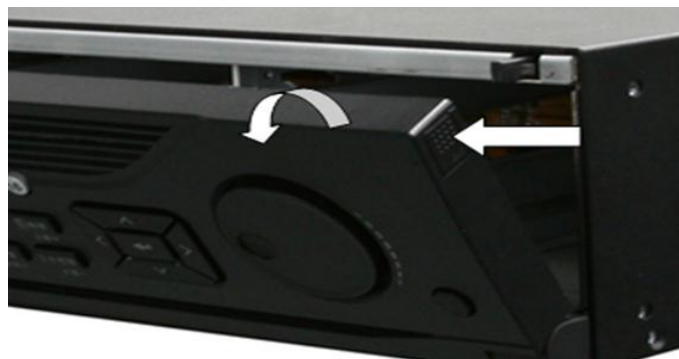

4. Insert the hard disk along the slot until it is placed into position.

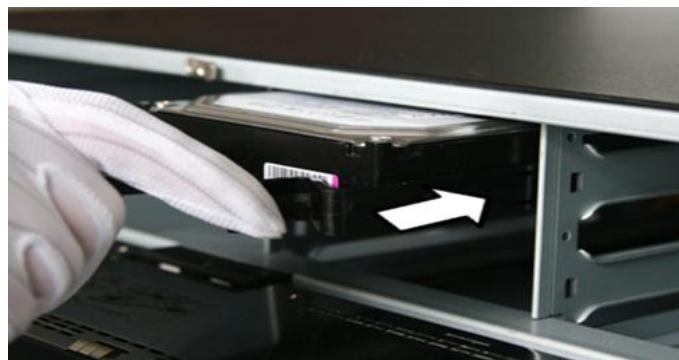

5. Repeat the above steps to install other hard disks onto the NVR. After having finished the installation of all hard disks, close the front panel and lock it with the key again.



## 2.3 Connections

### Wiring of Alarm Input

The alarm input is an open/closed relay. To connect the alarm input to the device, use the following diagram.



If the alarm input is not an open/close relay, please connect an external relay between the alarm input and the device.

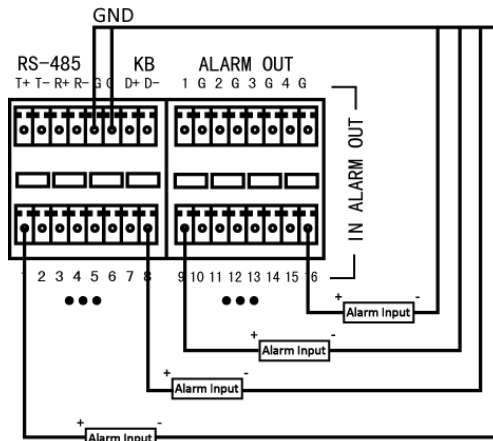

Figure 2.5 Alarm Input Wiring

### Wiring of Alarm Output

To connect to an alarm output (AC or DC load), use the following diagram:

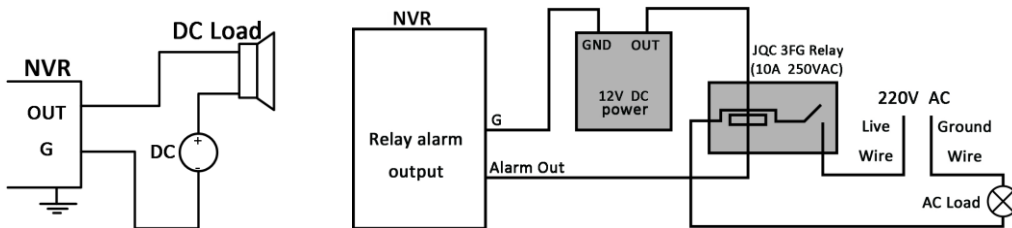

Figure 2.6 Alarm Output Wiring

For DC load, the jumpers can be used within the limit of 12V/1A safely.

To connect an AC load, jumpers should be left open (you must remove the jumper on the motherboard in the NVR). Use an external relay for safety (as shown in the figure above).

There are 4 jumpers (JP1, JP2, JP3, and JP4) on the motherboard, each corresponding with one alarm output. By default, jumpers are connected. To connect an AC load, jumpers should be removed.

**Example:**

If you connect an AC load to the alarm output 3 of the NVR, then you must remove the JP 3 jumper.

## Using Alarm Connectors

To connect alarm devices to the NVR:

1. Disconnect the *pluggable block* from the ALARM IN /ALARM OUT terminal block.
2. Unfasten stop screws from the *pluggable block*, insert signal cables into slots and fasten stop screws. Ensure signal cables are tight.
3. Connect the *pluggable block* back into terminal block.

## Controller Connection

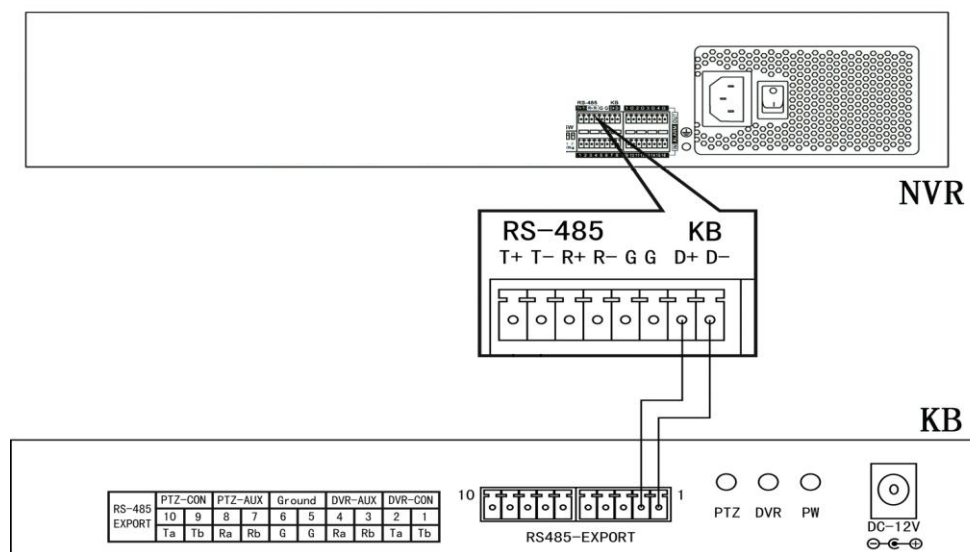

Figure 2.7 Controller Connection

To connect a controller to the NVR:

1. Disconnect pluggable block from the KB terminal block.
2. Unfasten stop screws from the KB D+, D- *pluggable block*, insert signal cables into slots and fasten stop screws. Ensure signal cables are in tight.
3. Connect Ta on controller to D+ on terminal block and Tb on controller to D- on terminal block. Fasten stop screws.
4. Connect the *pluggable block* back into terminal block.



Make sure both the controller and NVR are grounded.

## 2.4 HDD Storage Calculation Chart

The following chart shows an estimation of storage space used based on recording at one channel for an hour at a fixed bit rate.

Bit Rate	Storage Used
96K	42M
128K	56M
160K	70M
192K	84M
224K	98M
256K	112M
320K	140M
384K	168M
448K	196M
512K	225M
640K	281M
768K	337M
896K	393M
1024K	450M
1280K	562M
1536K	675M
1792K	787M
2048K	900M
4096K	1.8G
8192K	3.6G
16384K	7.2G



Please note that supplied values for storage space used is just for reference. The storage values in the chart are estimated by formulas and may have some deviation from actual value.

# Chapter 3 Menu Operation

## 3.1 Menu Structure

Refer to the following figure for the menu structure:

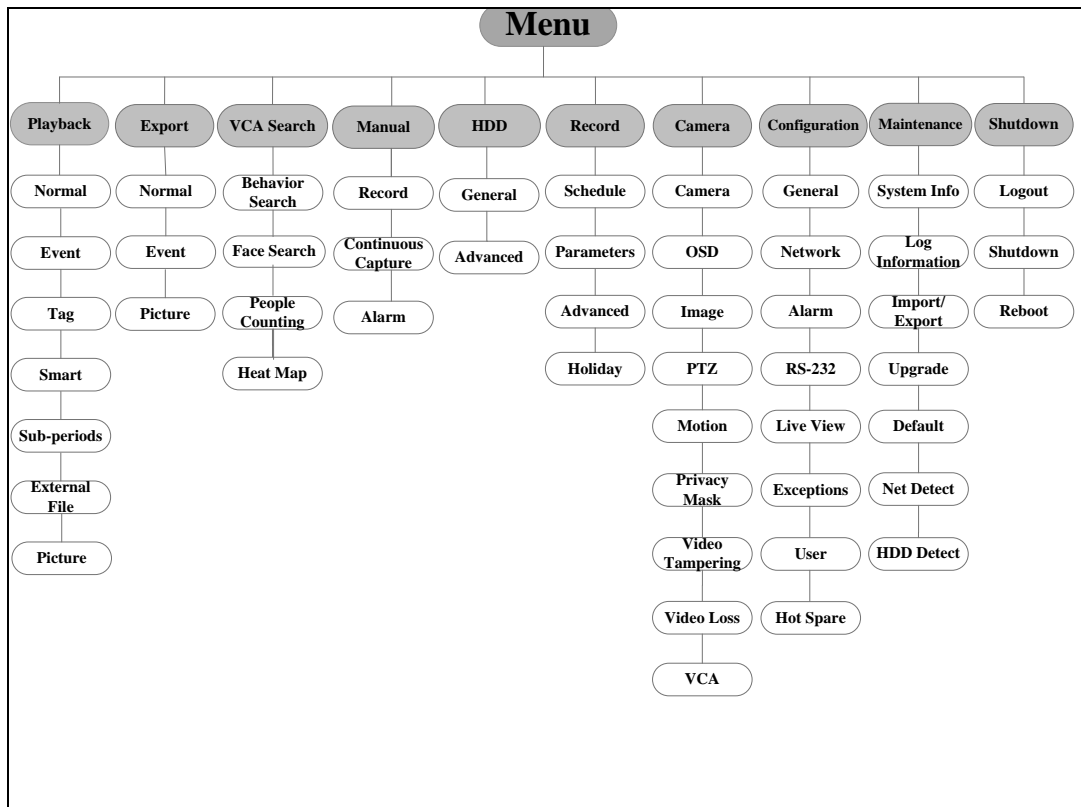

Figure 3. 1 Menu Structure



The menu structure may vary according to different models.

## 3.2 Startup and Shutdown

Proper startup and shutdown procedures are crucial to expanding the life of the NVR.

To start your NVR:

1. Check the power supply is plugged into an electrical outlet. It is **HIGHLY** recommended that an Uninterruptible Power Supply (UPS) be used in conjunction with the device. The Power button on the front panel should be red, indicating the device is receiving power.
2. Press the POWER button on the front panel. The Power LED should turn blue. The unit will begin to start. After the device starts up, the wizard will guide you through the initial settings, including modifying password, date and time settings, network settings, HDD initializing, and recording.

To shut down the NVR:

1. Enter the Shutdown menu.

Menu > Shutdown

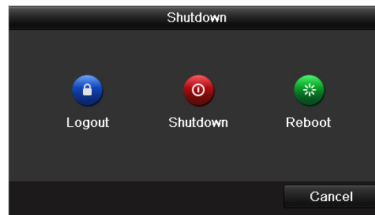

Figure 3. 2 Shutdown

2. Select the **Shutdown** button.
3. Click the **Yes** button.

## 3.3 Activating Your Device

### *Purpose:*

For the first-time access, you need to activate the device by setting an admin password. No operation is allowed before activation. You can also activate the device via Web Browser, SADP or client software.

### *Steps:*

1. Input the same password in the text field of **Create New Password** and **Confirm New Password**.

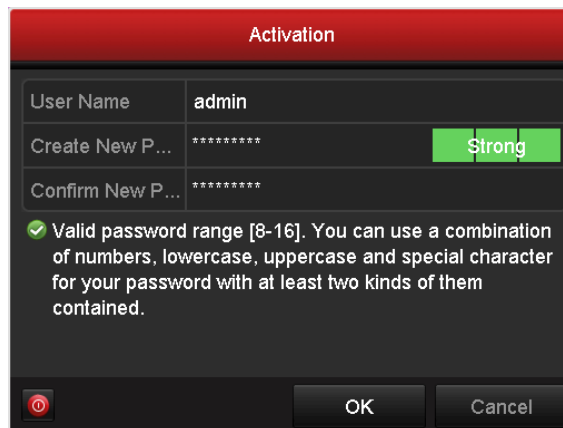

Figure 3. 3 Set Admin Password



**STRONG PASSWORD RECOMMENDED**– We highly recommend you create a strong password of your own choosing (using a minimum of 8 characters, including upper case letters, lower case letters, numbers, and special characters) in order to increase the security of your product. And we recommend you reset your password regularly, especially in high security applications, resetting the password monthly or weekly can better protect your product.

2. Click **OK** to save the password and activate the device.



For the older versions, if you upgrade it to the new version, the following dialog box will pop up once the

device starts up. You can click **YES** and follow the wizard to set a strong password.

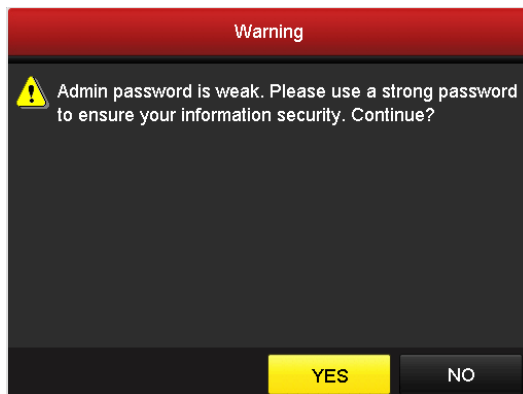

Figure 3. 4 Warning of Weak Password

## 3.4 Login and Logout

### User Login

*Purpose:*

If the NVR has logged out, you must login to the device before operating the menu and other functions.

*Steps:*

1. Select the **User Name** in the dropdown list.

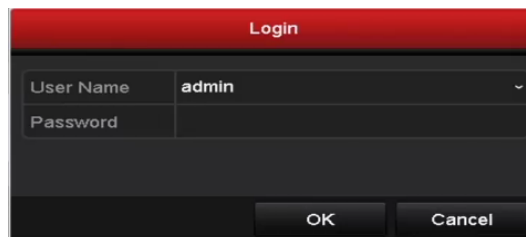

Figure 3. 5 Login

2. Input **Password**.
3. Click **OK** to log in.



In the Login dialog box, if you enter the wrong password 7 times, the current user account will be locked for 60 seconds.

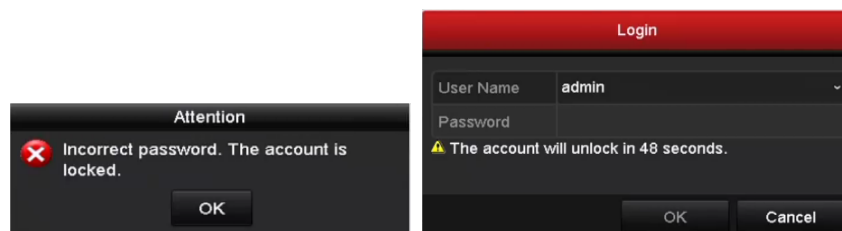

Figure 3. 6 Account Lock

## User Logout

### *Purpose:*

After logging out, the monitor turns to the live view mode and if you want to perform any operations, you need to enter user name and password to log in again.

### *Steps:*

1. Enter the Shutdown menu.  
Menu > Shutdown

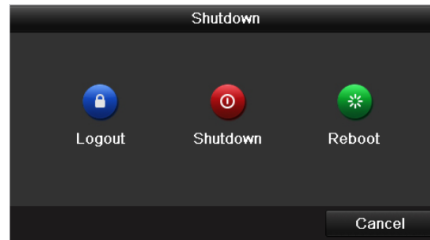

Figure 3.7 Logout

2. Click **Logout**.



After you have logged out of the system, menu operation on the screen is invalid. It is required to input a user name and password to unlock the system.

## 3.5 Using the Setup Wizard

The Setup Wizard can walk you through some important settings of the device. By default, the Setup Wizard starts once the device has loaded.

Check the checkbox to enable Setup Wizard when device starts. Click **Next** to continue the setup wizard. Follow the guide of the Setup Wizard to configure the system resolution, system date/time, network settings, HDD management, record settings, etc.



Figure 3.8 Wizard

## 3.6 Network Settings

### *Purpose:*

Network settings must be properly configured before you operate the NVR over the network.

### *Steps:*

1. Enter the Network Settings interface.

Menu > Configuration > Network

Working Mode	Net Fault-tolerance		
Select NIC	bond0		
NIC Type	10M/100M/1000M Self-adaptive		
Enable DHCP	<input type="checkbox"/>		
IPv4 Address	10 . 16 . 1 . 96	IPv6 Address	fe80::c256:e3ff:fe2b:e1e1/64
IPv4 Subnet	255 . 255 . 255 . 0	IPv6 Address	
IPv4 Default	10 . 16 . 1 . 254	IPv6 Default	
MAC Address	c0:56:e3:2b:e1:e1		
MTU(Bytes)	1500		
Preferred DNS Server			
Alternate DNS Server			
Main NIC	LAN1		

Figure 3.9 Network Settings



Two self-adaptive 10M/100M/1000M network interfaces provided for non POE series, and two working modes are configurable: multi-address and network fault tolerance. And one self-adaptive 10M/100M/1000M network interface for PoE series.

2. Select the **General** tab.
3. In the **General Settings** interface, you can configure the following settings: NIC Type, IPv4 Address, IPv4 Gateway, MTU and DNS Server.  
If a DHCP server is available, you can check the checkbox of **DHCP** to automatically obtain an IP address and other network settings from that server.
4. After having configured the general settings, click the **Apply** button to save the settings.

## 3.7 Adding IP Cameras

### *Purpose:*

Before you can get live video or record the video files, you should add the network camera(s) to the connection list of the device.

### *Before you start:*

Ensure the network connection is valid and correct, and the IP camera to add has already been activated. Please refer to the *User Manual* for activating the inactive IP camera.

You can select one of the following three options to add the IP camera(s).

- **OPTION 1:**

*Steps:*

1. Click to select an idle window in the live view mode.
2. Click the  icon in the center of the window to pop up the Add IP Camera interface.

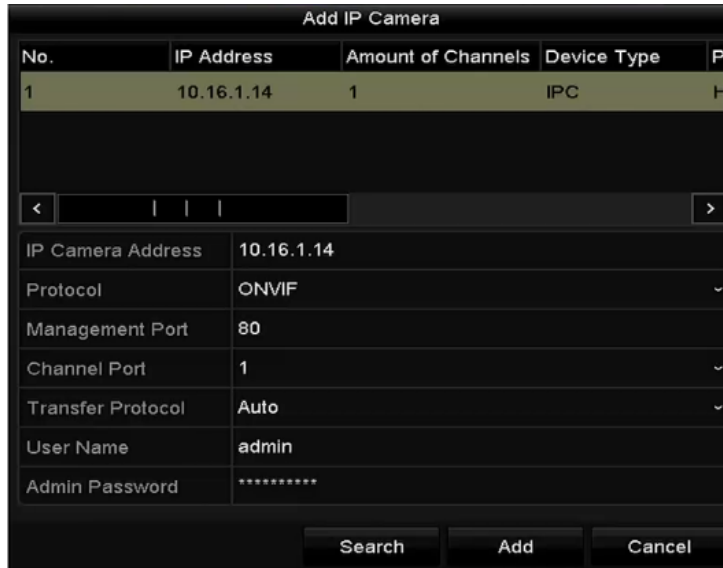

No.	IP Address	Amount of Channels	Device Type	Pl
1	10.16.1.14	1	IPC	H

IP Camera Address: 10.16.1.14

Protocol: ONVIF

Management Port: 80

Channel Port: 1

Transfer Protocol: Auto

User Name: admin

Admin Password: \*\*\*\*\*

Search Add Cancel

Figure 3. 10 Add IP Camera

3. Select the detected IP camera and click the **Add** button to add it directly, you can click the **Search** button to refresh the online IP camera manually.  
Or you can choose to custom add the IP camera by editing the parameters in the corresponding text field and then click the **Add** button to add it.

## 3.8 Live View

Icons are provided on screen in Live View mode to indicate camera status. These icons include:

### Live View Icons

In the live view mode, there are icons at the upper-right corner of the screen for each channel, showing the status of the record and alarm in the channel for quick reference.



Alarm (video loss, tampering, motion detection, VCA or sensor alarm)



Record (manual record, continuous record, motion detection, VCA or alarm triggered record)

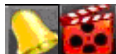

Alarm and Record



Event/Exception (event and exception information, appears at the lower-left corner of the screen.)

## 3.9 One-Touch RAID Configuration



The RAID is supported by 2U series NVRs only.

**Purpose:**

The device supports the RAID storage function. Through one-touch configuration, you can quickly create the disk array. By default, the array type to be created is RAID 5.

**Before you start:**

As the default array type is RAID 5, at least 3 HDDs must be installed in you device. And if more than 10 HDDs are installed, 2 arrays can be configured.

**Steps:**

1. Enter the Physical Disk Settings interface.

Menu > HDD > RAID

No.	Capacity	Array	Type	Status	Model	Hot Sp...
1	931.51GB		Normal	Functional	ST31000340NS	
3	931.51GB		Normal	Functional	ST31000526SV	
5	931.51GB		Normal	Functional	WDC WD10EVVS-6...	
7	931.51GB		Normal	Functional	WDC WD10EVVS-6...	

Figure 3. 11 RAID Settings Interface

2. Click **One-touch Configuration** to enter the One-touch Array Configuration interface.

One-touch Array Configuration

Array Name

OK Cancel

Figure 3. 12 One-touch Array Configuration

3. Edit the array name in the **Array Name** text field and click **OK** button to start configuring array.



If you install 4 HDDs or more for one-touch configuration, a hot spare disk will be set by default. It is recommended to set a hot spare disk for automatically rebuilding the array when the array is abnormal.

4. When the array configuration is completed, click **OK** button in the pop-up message box to finish the settings.

## 3.10 Recording Settings

### *Before you start:*

Make sure that the disk has already been installed. If not, please install a disk and initialize it. You may refer to the user manual for detailed information.

### *Purpose:*

Two kinds of record types are introduced in the following section, including Instant Record and All-day Record. And for other record types, you may refer to the user manual for detailed information.

### *Steps:*

1. On the live view window, right click the window and move the cursor to the **Start Recording** option, and select **Continuous Record** or **Motion Detection Record**.

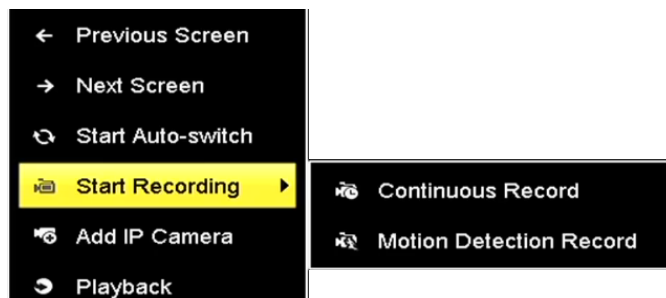

Figure 3. 13 Start Recording from Right-click Menu

2. Click the **Yes** button in the pop-up Attention message box to confirm the settings. All the channels will start to record in the selected mode.

## 3.11 Playback

The recorded video files on the hard disk can be played back in the following modes: instant playback, all-day playback for the specified channel, and playback by normal/event/smart/tag/sub-periods/external file search.

### *Steps:*

1. Enter playback interface.  
Click Menu> Playback or from the right-click menu.
2. Check the checkbox of channel(s) in the channel list and then double-click to select a date on the calendar.
3. You can use the toolbar in the bottom part of Playback interface to control playing progress.



Figure 3. 14 Playback Interface

Select the channel (s) you want to play back by checking the checkbox (es), or execute simultaneous playback of multiple channels.

## Chapter 4 Remote Access

### 4.1 Web Browser



You shall acknowledge that the use of the product with Internet access might be under network security risks. To mitigate network attacks and information leakage, please ensure the network is protected. If the product does not work properly, please contact your dealer or the nearest service center.

**Purpose:**

You can get access to the device via web browser. You may use one of the following listed web browsers: Internet Explorer 6.0, Internet Explorer 7.0, Internet Explorer 8.0, Internet Explorer 9.0, Internet Explorer 10.0, Apple Safari, Mozilla Firefox, and Google Chrome. The supported resolutions include 1024\*768 and above.

**Steps:**

1. Open web browser, input the IP address of the device and then press Enter.
2. Log in to the device.
  - If the device has not been activated, you need to activate the device first before login.

Figure 4. 1 Set Admin Password

- 1) Set the password for the admin user account.
- 2) Click **OK** to log in to the device.



**STRONG PASSWORD RECOMMENDED**– We highly recommend you create a strong password of your own choosing (using a minimum of 8 characters, including upper case letters, lower case letters, numbers, and special characters) in order to increase the security of your product. And we recommend you reset your password regularly, especially in high security applications, resetting the password monthly or weekly can better protect your product.

- If the device is already activated, enter the user name and password in the login interface, and click the **Login** button.

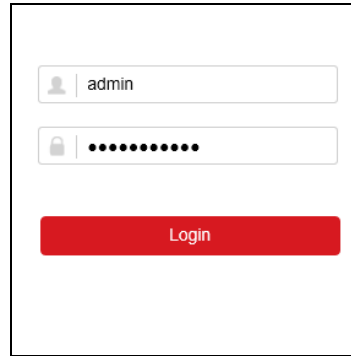

Figure 4. 2 Login

---

3. Install the plug-in before viewing the live video and managing the camera. Please follow the installation prompts to install the plug-in.

**Note:**

You may have to close the web browser to finish the installation of the plug-in.

After logging in, you can perform regular operation and configuration, including live view, playback, log search, configuration, etc.

## 4.1 Mobile Apps

You shall acknowledge that the use of the product with Internet access might be under network security risks. To mitigate network attacks and information leakage, please ensure the network is protected. If the product does not work properly, please contact your dealer or the nearest service center.

**Purpose:**

Once the device is configured on the network, and there are no restrictions in place preventing the recorder from accessing the internet, you can access the DVR from a mobile device to view live video as well as playback.

**Steps:**

1. Download the "STGO2" application onto the mobile device(s) that will be accessing the DVR
2. Select the country it will be operated in, and select LOGIN
  - If the device has not been activated, you need to activate the device first.
  - This tutorial covers Cloud P2P connection, DDNS and direct IP are other options



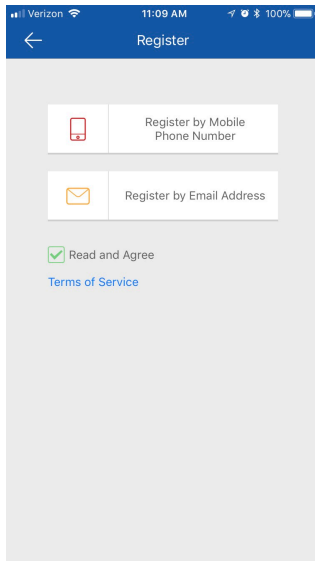

Figure 4.3 Registration

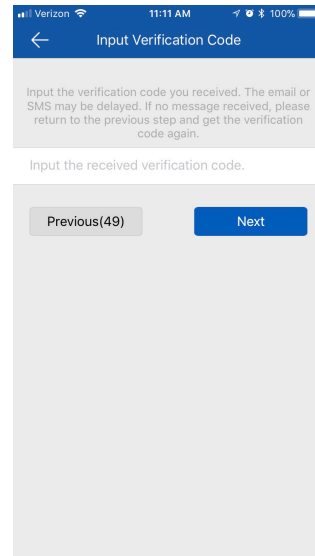

Figure 4.4 Verification

3. Accept the terms of service, and select a registration method.
4. Verify the account using the code sent to either the email address or phone number used.

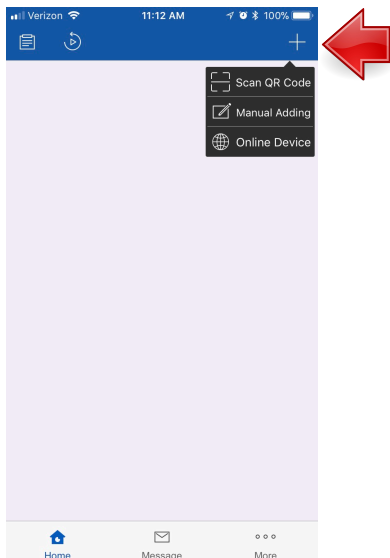

Figure 4.4 Add Device

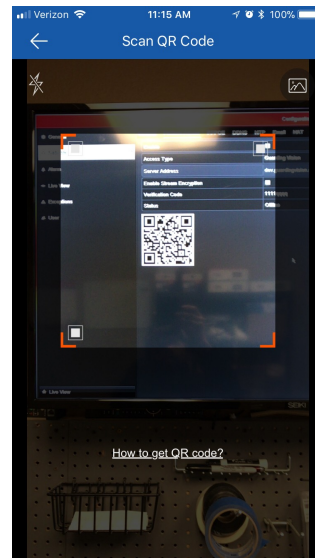

Figure 4.5 QR Scan

5. Click on the "+" icon in the upper right corner, then scan the QR code displayed in the MENU>CONFIGURATION>NETWORK>ACCESS PLATFORM sub-menu of the DVR
6. You will then need to enter the Verification code on that same screen into the mobile app
7. Once added, you can now access Live/ Playback streams from the mobile device

**SECURITYTRONIX 2-Year Limited Stand Alone Digital Video Recorder Warranty**

Securitytronix. (the "Company") warrants to the Original Purchaser that the Stand Alone Digital Video Recorder is free from defects in workmanship or material under normal use. This warranty starts on the date of shipment of the hardware to the Original Purchaser. Any Hard Drive installed in the Stand Alone Digital Video Recorder is the warranty responsibility of the Hard Drive Manufacturer and is not covered by this or any other Securitytronix warranties. During the warranty period, the Company agrees to repair or replace, at its sole option, without charge to Original Purchaser, any defective component in the Stand Alone Digital Video Recorder. To obtain service, the Original Purchaser must return the Stand Alone Digital Video Recorder to the Company properly packaged for shipping. All defective products must be returned to the Company within thirty (30) days of failure. Products must be returned with a description of the failure and Return Merchandise Authorization (RMA) number supplied by the Company. To receive a RMA number and a return shipping address on where to deliver the hardware, call 610-429-1821. The shipping, and insurance charges incurred in shipping to the Company will be paid by Original Purchaser, and all risk for the hardware shall remain with the Original Purchaser until such time as Company takes receipt of the hardware. Upon receipt, the Company will promptly repair or replace the defective unit, and then return said unit to Original Purchaser, shipping prepaid. The Company may use reconditioned or like-new parts or units, at its sole option, when repairing any hardware. Repaired products shall carry the same amount of outstanding warranty as from original purchase. Any claim under the warranty must include dated proof of purchase or invoice. In any event, the Company's liability for defective hardware is limited to repairing or replacing the hardware. This warranty is contingent upon proper use of the hardware by Original Purchaser and does not cover: if damage is due to Acts of God (including fire, flood, earthquake, storm, hurricane or other natural disaster), accident, unusual physical, electrical, or electromechanical stress, modifications, neglect; misuse, operation with media not approved by the Company, tampering with or altering of the hardware, war, invasion, act of foreign enemies, hostilities (regardless of whether war is declared), civil war, rebellion, revolution, insurrection, military or usurped power or confiscation, terrorist activities, nationalization, government sanction, blockage, embargo, labor dispute, strike, lockout or interruption or failure of electricity, air conditioning, or humidity control, internet, network, or telephone service The warranties given herein, together with any implied warranties covering the hardware, including any warranties of merchantability or fitness for a particular purpose, are limited in duration to two years from the date of shipment to the Original Purchaser. Jurisdictions vary with regard to the enforceability of warranty limitations, and you should check the laws of your local jurisdiction to find out whether the above limitation applies to you. The Company shall not be liable to you for loss of data, loss of profits, lost savings, special, incidental, consequential, indirect, or other similar damages arising from breach of warranty, breach of contract, negligence, or other legal action even if the Company or its agent has been advised of the possibility of such damages, or for any claim brought against you by another party. Jurisdictions vary with regard to the enforceability of provisions excluding or limiting liability for incidental or consequential damages. You should check the laws of your local jurisdiction to find out whether the above exclusion applies to you. This warranty allocates risks of product failure between Original Purchaser and the Company. The Company's hardware pricing reflects this allocation of risk and the limitations of liability contained in this warranty. The warranty set forth above is in lieu of all other express warranties, whether oral or written. The agents, employees, distributors, and dealers of the Company are not authorized to make modification to this warranty, or additional warranties binding on the Company. Accordingly, additional statements such as dealer advertising or presentations, whether oral or written, do not constitute warranties by the Company and should not be relied upon. This warranty gives you specific legal rights. You may also have other rights which vary from one jurisdiction to another.

For further assistance, or if you encounter any issue while using this product, please contact your distributor or Securitytronix at: 800-688-9282 Press 3 for support, then 2 for CCTV.