

IP-POE4 / IP-POE8

User Manual

User Manual

Legal Disclaimer

TO THE MAXIMUM EXTENT PERMITTED BY APPLICABLE LAW, THE PRODUCT DESCRIBED, WITH ITS HARDWARE, SOFTWARE AND FIRMWARE, IS PROVIDED “AS IS”, WITH ALL FAULTS AND ERRORS, AND THE MANUFACTURER MAKES NO WARRANTIES, EXPRESS OR IMPLIED, INCLUDING WITHOUT LIMITATION, MERCHANTABILITY, SATISFACTORY QUALITY, FITNESS FOR A PARTICULAR PURPOSE, AND NON-INFRINGEMENT OF THIRD PARTY. IN NO EVENT WILL THE MANUFACTURER, ITS DIRECTORS, OFFICERS, EMPLOYEES, OR AGENTS BE LIABLE TO YOU FOR ANY SPECIAL, CONSEQUENTIAL, INCIDENTAL, OR INDIRECT DAMAGES, INCLUDING, AMONG OTHERS, DAMAGES FOR LOSS OF BUSINESS PROFITS, BUSINESS INTERRUPTION, OR LOSS OF DATA OR DOCUMENTATION, IN CONNECTION WITH THE USE OF THIS PRODUCT, EVEN IF THE MANUFACTURER HAS BEEN ADVISED OF THE POSSIBILITY OF SUCH DAMAGES.

REGARDING TO THE PRODUCT WITH INTERNET ACCESS, THE USE OF PRODUCT SHALL BE WHOLLY AT YOUR OWN RISKS. THE MANUFACTURER SHALL NOT TAKE ANY RESPONSIBILITIES FOR ABNORMAL OPERATION, PRIVACY LEAKAGE OR OTHER DAMAGES RESULTING FROM CYBER ATTACK, HACKER ATTACK, VIRUS INSPECTION, OR OTHER INTERNET SECURITY RISKS; HOWEVER, THE MANUFACTURER WILL PROVIDE TIMELY TECHNICAL SUPPORT IF REQUIRED. SURVEILLANCE LAWS VARY BY JURISDICTION. PLEASE CHECK ALL RELEVANT LAWS IN YOUR JURISDICTION BEFORE USING THIS PRODUCT IN ORDER TO ENSURE THAT YOUR USE CONFORMS THE APPLICABLE LAW. THE MANUFACTURER SHALL NOT BE LIABLE IN THE EVENT THAT THIS PRODUCT IS USED WITH ILLEGITIMATE PURPOSES. IN THE EVENT OF ANY CONFLICTS BETWEEN THIS MANUAL AND THE APPLICABLE LAW, THE LATER PREVAILS.

Regulatory Information



CE Mark Warning

This is a Class A product. In a domestic environment, this product may cause radio interference, in which case the user may be required to take adequate measures.

NOTE: (1) The manufacturer is not responsible for any radio or TV interference caused by unauthorized modifications to this equipment. (2) To avoid unnecessary radiation interference, it is recommended to use a shielded RJ45 cable.



FCC Statement

This equipment has been tested and found to comply with the limits for a Class A digital device, pursuant to part 15 of the FCC Rules. These limits are designed to provide reasonable protection against harmful interference when the equipment is operated in a commercial environment. This equipment generates, uses, and can radiate radio frequency energy and, if not installed and used in accordance with the instruction manual, may cause harmful interference to radio communications. Operation of this equipment in a residential area is likely to cause harmful interference in which case the user will be required to correct the interference at his own expense.

This device complies with part 15 of the FCC Rules. Operation is subject to the following two conditions: (1) This device may not cause harmful interference, and (2) this device must accept any interference received, including interference that may cause undesired operation. The manufacturer is not responsible for any radio or TV interference caused by unauthorized modifications to this equipment.

Caution!

Any changes or modifications not expressly approved by the party responsible for compliance could void the user's authority to operate the equipment.

NOTE: (1) The manufacturer is not responsible for any radio or TV interference caused by unauthorized modifications to this equipment. (2) To avoid unnecessary radiation interference, it is recommended to use a shielded RJ45 cable.

IC

CAN ICES-3 (A) /NMB-3 (A)



Safety Instruction

These instructions are intended to ensure that user can use the product correctly to avoid danger or property loss.

The precaution measure is divided into “Warnings” and “Cautions”

Warnings: Serious injury or death may occur if any of the warnings are neglected.

Cautions: Injury or equipment damage may occur if any of the cautions are neglected.

	
Warnings Follow these safeguards to prevent serious injury or death.	Cautions Follow these precautions to prevent potential injury or material damage.



Warnings

- Proper configuration of all passwords and other security settings is the responsibility of the installer and/or end-user.
- In the use of the product, you must be in strict compliance with the electrical safety regulations of the nation and region. Please refer to technical specifications for detailed information.
- Input voltage should meet both the SELV (Safety Extra Low Voltage) and the Limited Power Source with 100~240 VAC or 12 VDC according to the IEC60950-1 standard. Please refer to technical specifications for detailed information.
- Do not connect several devices to one power adapter as adapter overload may cause over-heating or a fire hazard.
- Please make sure that the plug is firmly connected to the power socket.
- If smoke, odor or noise rise from the device, turn off the power at once and unplug the power cable, and then please contact the service center.

Preventive and Cautionary Tips

Before connecting and operating your device, please be advised of the following tips:

- Ensure unit is installed in a well-ventilated, dust-free environment.
- Unit is designed for indoor use only.
- Keep all liquids away from the device.
- Ensure environmental conditions meet factory specifications.
- Ensure unit is properly secured to a rack or shelf. Major shocks or jolts to the unit as a result of dropping it may cause damage to the sensitive electronics within the unit.
- Use the device in conjunction with an UPS if possible.
- Power down the unit before connecting and disconnecting accessories and peripherals.
- A factory recommended HDD should be used for this device.
- Improper use or replacement of the battery may result in hazard of explosion. Replace with the same or equivalent type only. Dispose of used batteries according to the instructions provided by the battery manufacturer.

Thank you for purchasing our product. If there is any question or request, please do not hesitate to contact dealer.

The figures in the manual are for reference only.

This manual is applicable to the models listed in the following table.

Model
IP-POE4
IP-POE8

TABLE OF CONTENTS

Chapter 1	Product Overview.....	7
1.1	Introduction	7
1.2	Packages Content	7
1.3	Front Panel	8
1.4	Rear Panel	9
Chapter 2	Device Installation.....	11
2.1	Installation Notes.....	11
	Safety Alert	11
	Environmental Requests.....	11
2.2	Installation.....	12
	Desktop-mounting.....	12
	Wall-mounting	12
2.3	Grounding.....	14
	With grounding bar	14
	Without grounding bar	14
Chapter 3	Physical Connection	16
3.1	Connect to RJ45 Ports	16
3.2	Check the Cabling	16
3.3	Connect to Power Supply	17
Appendix	Technical Specifications	18

Chapter 1 Product Overview

1.1 Introduction

IP-POE4 / IP-POE8 is a series of 10/100Mbps desktop PoE switch. It provides 5/9 10/100Mbps auto-negotiation RJ45 ports, in which ports 1-4/8 support IEEE 802.3af PoE (15.4W) and IEEE 802.3at PoE+ (30W). The whole PoE power output is 58W/120W. With Cat 5 Ethernet cable, power and data can be simultaneously transmitted to APs, IP cameras, IP phones, and other PDs (Power devices).

In addition, IP-POE4 / IP-POE8 supports Extend mode. With enabling extend mode and Cat 5e Ethernet cable, the transmission distance of data and power can be up to 250m.

1.2 Packages Content

Open your package and check the followings.

Item	Number
Switch	1
Power adapter	1
Footpads	4
Screws	2
Expansion screw tubes	2
User Manual	1

If any item is incorrect, missing, or damaged, please keep the original package and contact the vendor for replacement immediately.

1.3 Front Panel

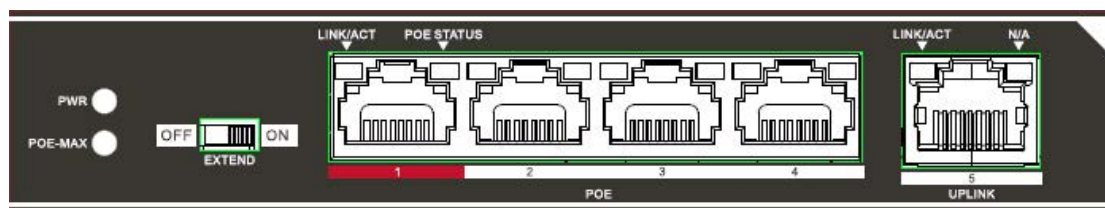

Figure 1.1 IP-POE4

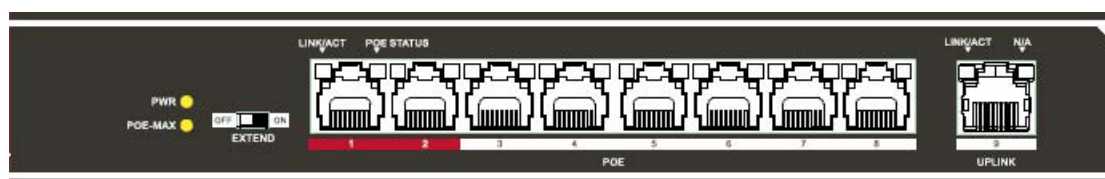

Figure 1.2 IP-POE8

Table 1. 1 Description of LEDs

LED	Status	Description
PWR	Solid	The device is connected to the power supply properly.
	Off	The device is connected improperly or not connected to the power supply.
POE-MAX	Solid	The PoE power gets to the alarm value, and the available PoE power is less than 6W.
	Blinking	The PoE power gets to the maximum.
	Off	The PoE power works properly, and the available PoE power is more than 6W.
LINK/ACT	Solid	The corresponding port is connected properly.
	Blinking	The corresponding port is transmitting data.
	Off	The corresponding port is connected improperly or not connected.
POE STATUS	Solid	The corresponding port is connected with a PD (Powered Device) and powers the PD properly.
	Blinking	The PoE output of the corresponding port exceeds 30W.
	Off	The corresponding port is no PoE power output or no PD connected.
N/A	Off	For reservation

✎ Extend Mode

Details for enabling extend mode:

Model	Name	Status	Description
IP-POE4	EXTEND	Off	Ports 1-4: 100M
		ON	Ports 1-4: 10M with Extend Mode being enabled
IP-POE8		Off	Ports 1-8: 100M
		ON	Ports 1-8: 10M with Extend Mode being enabled



Cautions

1. To guarantee the extend mode performance, please use Cat 5e or better Ethernet cable and configure the speed and duplex of the remote device to be "Auto Negotiation".
2. If Extend mode is OFF, the transmission distance of PoE powering and data is up to 150m by using Cat 5e or better Ethernet cable.

✎ RJ45 ports

Model	10/100Mbps RJ45 ports	Uplink port
IP-POE4	4	1
IP-POE8	8	1

Note that:

1. Ports 1-2 of IP-POE8 (Port 1 of IP-POE8) are with high priority by default, which take advantage over other ports to process key data or video data.
2. Ports 1-4/8 support IEEE 802.3af and IEEE 802.3at PoE power;

1.4 Rear Panel

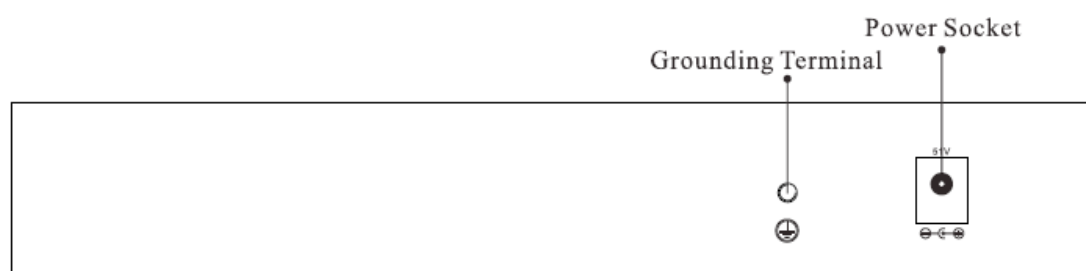

Figure 1.3 IP-POE4

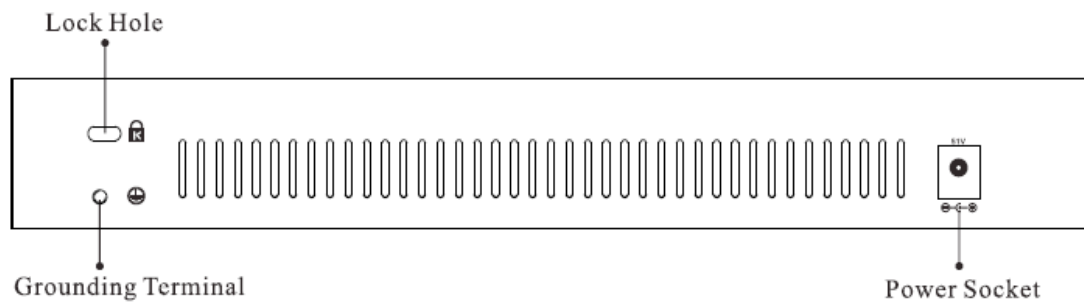

Figure 1 .4 IP-POE8

🔗 **Power Socket**

Used for connecting the included power adapter for power supply. Please use the included power adapter to connect the device to power supply.

🔗 **Grounding Terminal**

Used for connecting the grounding cable for lightning-resisting. The grounding details refer to Section

[2.3 Grounding](#)

🔗 **Lock Hole (Only for IP-POE8)**

This hole is used to lock the switch with another fixed object to prevent picking.

Chapter 2 Device Installation

(Here IP-POE8 is taken as an installation guide, which applies to IP-POE4.)

2.1 Installation Notes

To guarantee the device long service and your personal safety, please follow notes below.

Safety Alert

- Wear antistatic gloves while installing, and connect the device to power after finishing other installation.
- Use the included power adapter to power the device.
- Make sure the input voltage matches the value which is marked on the device's label.
- Place the device in a well-ventilated and dry environment.
- Do not open the cabinet of the device.
- Disconnect the device from the power supply when you are doing the cleaning.
- Position the device away from strong current.



Cautions

There is a seal covering one of the screws in the case of the device. In case of need repair, keep the seal unbroken until the agent supervise the maintenance. The user should not break the seal of the coverage without permission of the local agent, otherwise will be responsible for any damage.

Environmental Requests

Temperature/Humidity

Item	Temperature	Humidity
Operation Environment	0°C - 40°C	10% - 90% RH (non-condensing)
Storage Environment	-40°C -70°C	5% - 90% RH (non-condensing)

Antistatic Precautions

Dust may lead to electrostatic adsorption. To protect the device from static electricity harm, please pay attention to the following:

- Keep the device environment air clean. (A regular dusting is necessary)

- Make sure the device is grounded well.

⚡ Lightning Protection

In a thunderstorm weather, a sudden current may damage the device. To protect the device from lightning stroke or strong current, please:

- Make sure the device, the installation desktop and power outlet on the wall all are well-grounded.
- Cable the device properly; and if you need to cable outdoors, it is advisable to set up with a signal lightning arrester.

⚡ Mounting Standards

No matter whether it is wall-mounting or desktop-mounting, follow the instructions below.

- The desktop is stable and sturdy enough.
- Place the device in a clean, dry and well-ventilated environment. Keep at least 10cm free on all sides for cooling.
- Do not place any heavy or big size object on the device.
- Keep at least 1.5cm vertical distance between each device while installing it in stack.

2.2 Installation

The device supports two types of installation: wall-mounting and desktop-mounting. Install your device according to the tools you have. Here IP-POE8 is taken as an installation guide, which applies to IP-POE4.

Desktop-mounting

Find a flat and stable desktop and place the switch correctly.

Wall-mounting

Step 1: Prepare the following tools.



Figure 2.1 Installation Tools

Step 2: Drill two 6mm diameter holes, about 110mm (IP-POE8) away apart on the same level in the wall.
(93mm for IP-POE4)

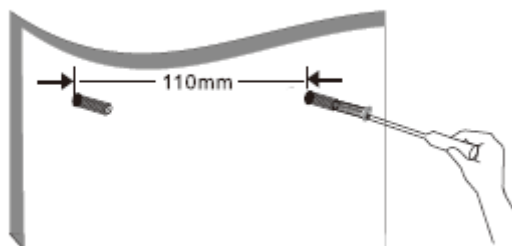

Figure 2.2 Drill holes in the wall

Step 3: Insert the expansion screw tubes completely into the holes in the wall with rubber hammer.

Step 4: Tighten the expansion tubes and screws with Phillips screwdriver. In order to mount the switch to the wall firmly, the distance between the screw head and the tube head must be kept at least 2.5mm wide.

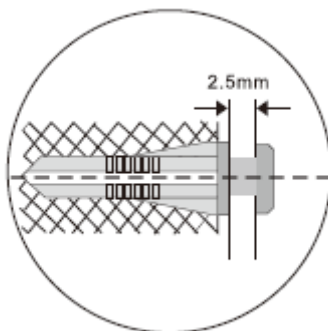

Figure 2.3 Tighten the expansion tubes

Step 5: Place the switch onto the mounting screws, and slide it down until it locks in place.

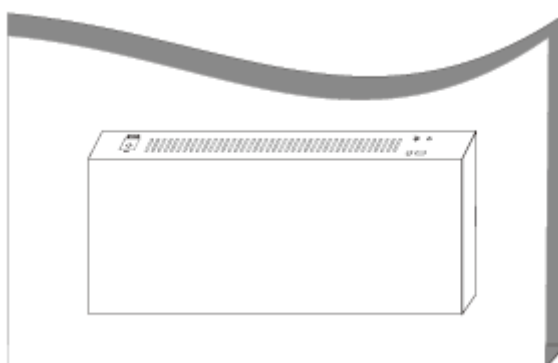

Figure 2.4 Hang the switch against the wall

2.3 Grounding

Grounding is not only important for lightning arresting and anti-interference, but for your own personal safety. Please select the proper method to ground your device.

With grounding bar

If a grounding bar is available at the installation site, follow steps below to ground the device.

- 1) Connect one end of the grounding cable to the binding post on the grounding bar.
- 2) Connect the other end of the grounding cable to the grounding terminal and fix the screw.

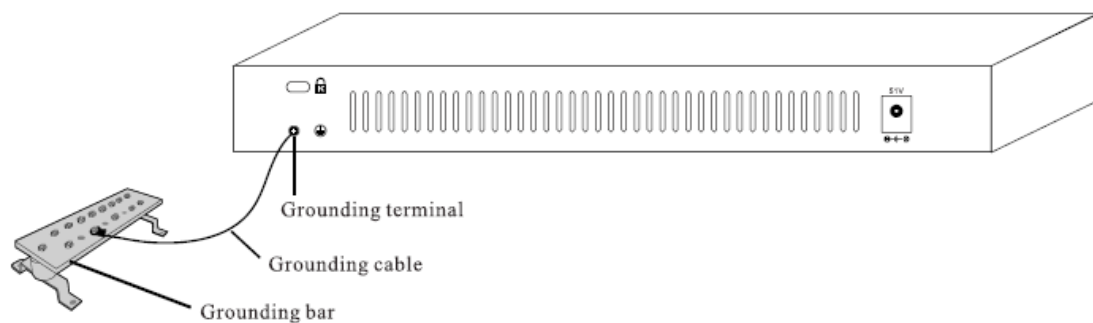

Figure 2.5 Connect to the grounding bar



Cautions

Connect the grounding cable to the earthing system in the equipment room. Do not connect it to a fire main or lightning.

Without grounding bar

- If there is no grounding bar but earth nearby and the grounding body is allowed to be buried, follow below steps:

- 1) Bury an angle steel or steel pipe ($\geq 0.5\text{m}$) into the mud land.
- 2) Weld one end of the grounding cable to the angle steel or steel pipe and embalm the welding point.
- 3) Connect the other end of the grounding cable to the grounding terminal and fix the screw.

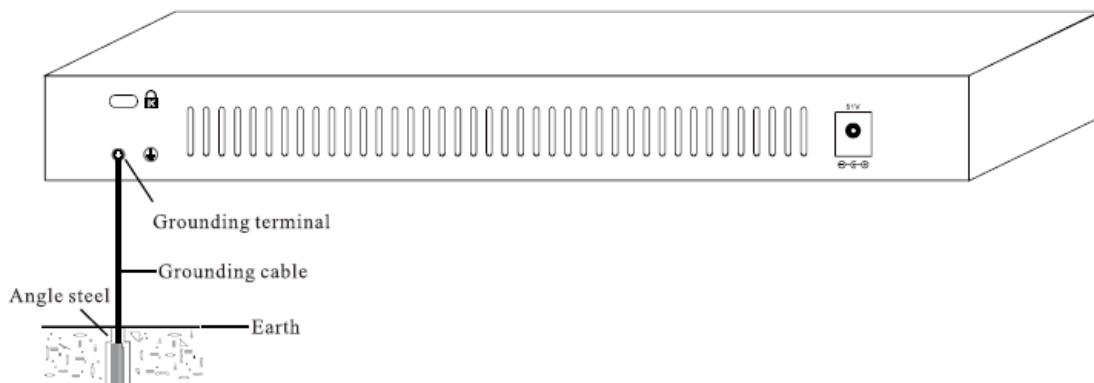

Figure 2.6 Ground with an angle steel

- If both ground bar and the conditions for burying the grounding body are not available, an AC-powered Ethernet switch can be grounded using the PE (Protecting Earth) wire of the AC power supply.



Figure 2.7 Ground with 3-core AC power cord



Cautions

Make sure that the PE wire of the AC power supply has been well grounded at the side of the power distribution room or AC power supply transformer.

Chapter 3 Physical Connection

3.1 Connect to RJ45 Ports

Connect the switch to a remote device with Ethernet cable via RJ45 port. UPLINK is the uplink port. Ports 1-4/8 support IEEE 802.3af and IEEE 802.3at PoE supply, and the PD can be wireless AP, IP phone or IP camera, etc.

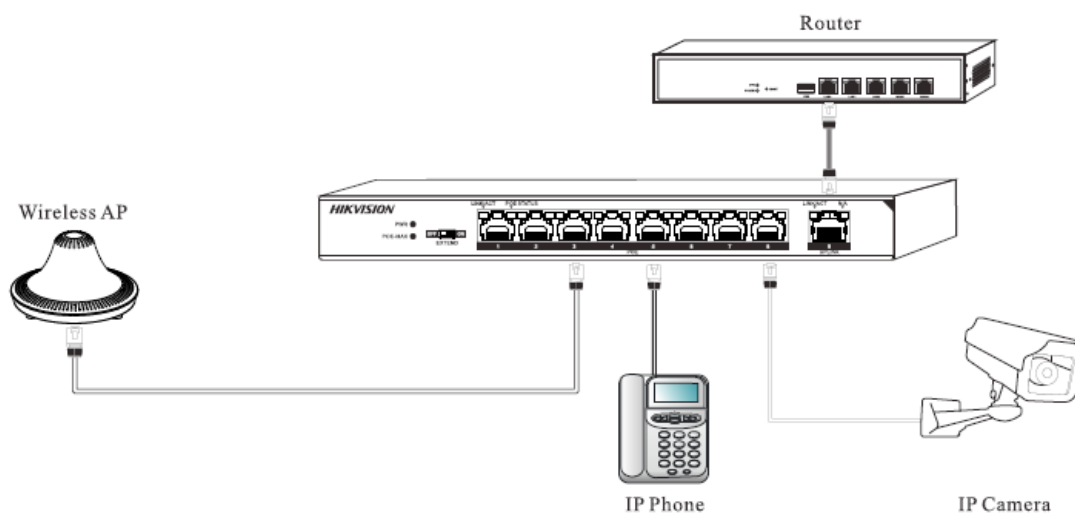

Figure 3.1 RJ45 port connection

Note that:

- *Cat.5e or better Ethernet cable is recommended. As each RJ45 port supports MDI/MDIX auto-negotiating, either parallel or crossover cable is available.*
 - *The device supports dynamic PoE supply. Namely, the device will power the PD properly and automatically.*
-

3.2 Check the Cabling

Once installation is completed, check the cabling of the device as the following:

- The operating power supply should accord with rated input standard.
- Ports cabling and grounding cable are correctly connected.
- If there is outdoor cabling, connect a lightning protector to the cable before you plug the cable into the port.

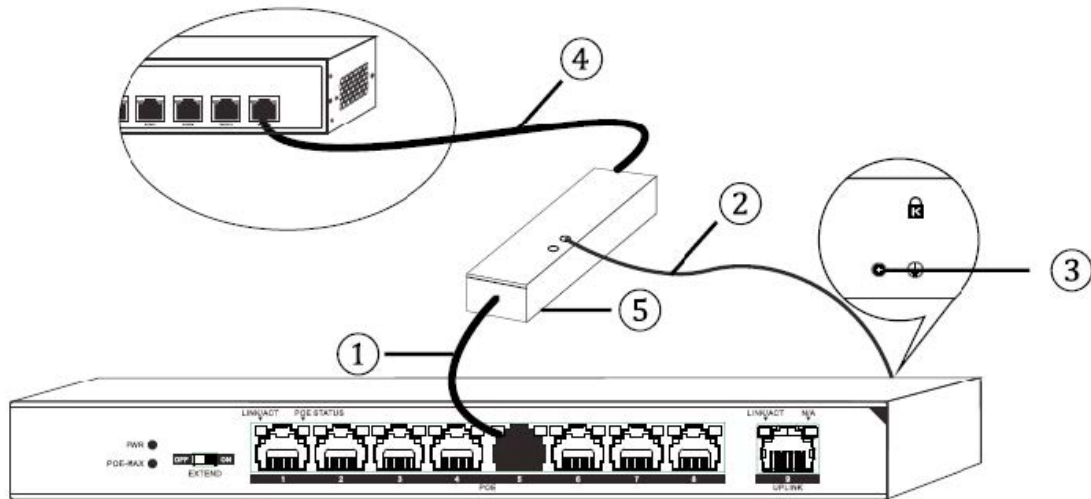

Figure 3.2 Lightning protector connection

- ① Ethernet cable
- ② Grounding cable
- ③ Grounding terminal
- ④ Outdoor cabling
- ⑤ Lightning protector

3.3 Connect to Power Supply

Please use the included power adapter for power supply.

Appendix Technical Specifications

Item		IP-POE4	IP-POE8
Interfaces	10/100Mbps RJ45 ports	5	9
	High priority ports	Port 1	Ports 1-2
Performance	Store-and-forward	Supported	
	MAC Table	1k	4k
	MAC Learning	Auto-learning/ Auto-aging	
	Switching Capacity	1Gbps	1.8Gbps
PoE Power	PoE standard	IEEE 802.3af, IEEE 802.3at	
	PoE Powering Mode	Supports 8 pins powering, which means pins 1,2,3,6 and pins 4,5,7,8 can power simultaneously	
	PoE Port	1-4	1-8
	Max Port Output	30W	30W
	Max Total Output	58W	120W
Extend Mode		Supported	
Lightning-proof Ranking	Port lightning proof	4KV	
	Power source lightning proof	4KV	2KV
Power Input		51V DC, 1.25A	51V DC, 2.5A
Physical Environment	Operating Environment	Temperature: 0°C-40°C Humidity: 10%-90% RH non-condensing	
	Storage Environment	Temperature: -40°C-70°C Humidity: 5%-90% RH non-condensing	
Transmission Speed		Ethernet: 10Mbps (Half Duplex) / 20Mbps (Full Duplex) Fast Ethernet: 100Mbps (Half Duplex) / 200Mbps (Full Duplex)	
Transmission Medium		Ethernet: Cat 3 or better UTP/STP Fast Ethernet: Cat 5 or better UTP/STP	
Network Standard		IEEE 802.3, IEEE 802.3u, IEEE 802.3af, IEEE802.3at, IEEE 802.3x	