

IP-NC328-VDZ

Quick Start Guide



About this Manual

The manual includes instructions for using and managing the product. Pictures, charts, images and all other information hereinafter are for description and explanation only. The information contained in the manual is subject to change, without notice, due to firmware updates or other reasons. Please find the latest version in the company website

Please use this user manual under the guidance of professionals.

Legal Disclaimer

REGARDING THE PRODUCT WITH INTERNET ACCESS, THE USE OF PRODUCT SHALL BE WHOLLY AT YOUR OWN RISKS. OUR COMPANY SHALL NOT TAKE ANY RESPONSIBILITIES FOR ABNORMAL OPERATION, PRIVACY LEAKAGE OR OTHER DAMAGES RESULTING FROM CYBER ATTACK, HACKER ATTACK, VIRUS INSPECTION, OR OTHER INTERNET SECURITY RISKS; HOWEVER, OUR COMPANY WILL PROVIDE TIMELY TECHNICAL SUPPORT IF REQUIRED.

SURVEILLANCE LAWS VARY BY JURISDICTION. PLEASE CHECK ALL RELEVANT LAWS IN YOUR JURISDICTION BEFORE USING THIS PRODUCT IN ORDER TO ENSURE THAT YOUR USE CONFORMS THE APPLICABLE LAW. OUR COMPANY SHALL NOT BE LIABLE IN THE EVENT THAT THIS PRODUCT IS USED FOR ILLEGITIMATE PURPOSES. IN THE EVENT OF ANY CONFLICTS BETWEEN THIS MANUAL AND THE APPLICABLE LAW, THE LATER PREVAILS.

Regulatory Information

FCC Information

Please take attention that changes or modification not expressly approved by the party responsible for compliance could void the user's authority to operate the equipment.

FCC compliance: This equipment has been tested and found to comply with the limits for a Class B digital device, pursuant to part 15 of the FCC Rules. These limits are designed to provide reasonable protection against harmful interference in a residential installation. This equipment generates, uses and can radiate radio frequency energy and, if not installed and used in accordance with the instructions, may cause harmful interference to radio communications. However, there is no guarantee that interference will not occur in a particular installation. If this equipment does cause harmful interference to radio or television reception, which can be determined by turning the equipment off and on, the user is encouraged to try to correct the interference by one or more of the following measures:

- Reorient or relocate the receiving antenna.
- Increase the separation between the equipment and receiver.
- Connect the equipment into an outlet on a circuit different from that to which the receiver is connected.
- Consult the dealer or an experienced radio/TV technician for help.

FCC Conditions

This device complies with part 15 of the FCC Rules. Operation is subject to the following two conditions:

1. This device may not cause harmful interference.
2. This device must accept any interference received, including interference that may cause undesired operation.

EU Conformity Statement



This product and - if applicable - the supplied accessories too are marked with "CE" and comply therefore with the applicable harmonized European standards listed under the EMC Directive 2014/30/EU, the RoHS Directive 2011/65/EU.



2012/19/EU (WEEE directive): Products marked with this symbol cannot be disposed of as unsorted municipal waste in the European Union. For proper recycling, return this product to your local supplier upon the purchase of equivalent new equipment, or dispose of it at designated collection points. For more information see: www.recyclethis.info



2006/66/EC (battery directive): This product contains a battery that cannot be disposed of as unsorted municipal waste in the European Union.

See the product documentation for specific battery information. The battery is marked with this symbol, which may include lettering to indicate cadmium (Cd), lead (Pb), or mercury (Hg). For proper recycling, return the battery to your supplier or to a designated collection point. For more information see: www.recyclethis.info

Industry Canada ICES-003 Compliance

This device meets the CAN ICES-3 (B)/NMB-3(B) standards requirements.

Safety Instruction

These instructions are intended to ensure that user can use the product correctly to avoid danger or property loss.

The precaution measure is divided into “Warnings” and “Cautions”

Warnings: Serious injury or death may occur if any of the warnings are neglected.

Cautions: Injury or equipment damage may occur if any of the cautions are neglected.



Warnings



WARNING: THIS PRODUCT CAN EXPOSE YOU TO POLYBROMINATED BIPHENYLS, WHICH IS KNOWN TO THE STATE OF CALIFORNIA TO CAUSE CANCER AND BIRTH DEFECTS OR OTHER REPRODUCTIVE HARM. FOR MORE INFORMATION GO TO WWW.PROP65WARNINGA.CA.GOV

- In the use of the product, you must be in strict compliance with the electrical safety regulations of the nation and region. Please refer to technical specifications for detailed information.
- Input voltage should meet both the SELV (Safety Extra Low Voltage) and the Limited Power Source with 12 VDC according to the IEC60950-1 standard. Please refer to technical specifications for detailed information.
- Do not connect several devices to one power adapter as adapter overload may cause over-heating or a fire hazard.
- Please make sure that the plug is firmly connected to the power socket. When the product is mounted on wall or ceiling, the device should be firmly fixed.
- If smoke, odor or noise rise from the device, turn off the power at once and unplug the power cable, and then please contact the service center.



Cautions

- Make sure the power supply voltage is correct before using the camera.
- Do not drop the camera or subject it to physical shock.
- Do not touch sensor modules with fingers. If cleaning is necessary, use clean cloth with a bit of ethanol and wipe it gently. If the camera will not be used for an extended period, please cap the lens to protect the sensor from dirt.

- Do not aim the camera at the sun or extra bright places. Blooming or smearing may occur otherwise (which is not a malfunction), and affect the endurance of the sensor at the same time.
- The sensor may be damaged by a laser beam, so when any laser equipment is in using, make sure that the surface of the sensor will not be exposed to the laser beam.
- Do not place the camera in extremely hot, cold (the operating temperature should be -22°F to +140°C), dusty or damp locations, and do not expose it to high electromagnetic radiation.
- To avoid heat accumulation, good ventilation is required in the operating environment.
- Keep the camera away from liquid while in use.
- During transport, the camera should be packed in its original packing, or packing of the same type.
- Improper use or replacement of the battery may result in hazard of explosion. Replace with the same or equivalent type only. Dispose of used batteries according to the instructions provided by the battery manufacturer.
- If the product does not work properly, please contact your dealer or the nearest service center. Never attempt to

disassemble the camera yourself. (We do not assume any responsibility for problems caused by unauthorized repair or maintenance.)

Table of Contents

1 Appearance Description	9
2 Installation.....	11
2.1 MemoryCard Installation.....	12
2.2 MountingPreparation.....	12
2.3 Camera Mounting.....	14
2.3.1 Ceiling Mounting.....	14
2.3.2 Wall Mounting.....	17
2.3.3 Pendant Mounting.....	19
3 Setting the Network Camera over the LAN	20
3.1 Wiring	20
3.2 Activating the Camera	21
3.3 Modifying the IP Address	24
4 Accessing via Web Browser	27
5 Operating via STGO2 App	29
5.1 Enable STGO2 Service on Camera	29
5.2 STGO2 Setup.....	32
5.3 Adding Camera to STGO2.....	32
5.4 Initializing the Memory Card	34

1 Appearance Description

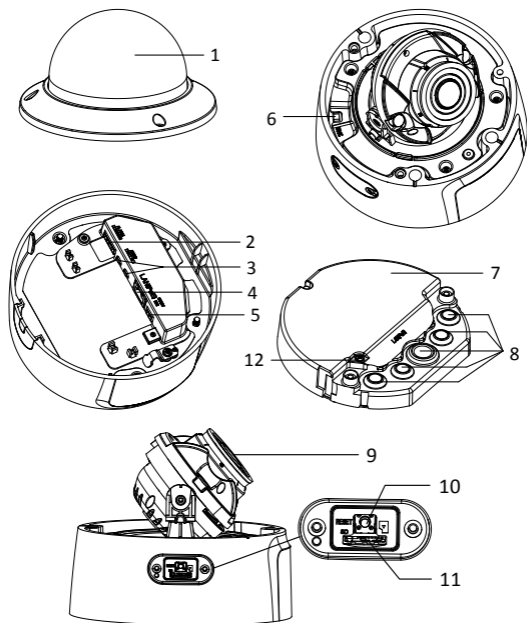

Figure 1-1 Overview of Dome Camera

No.	Description	No.	Description
1	Dome	7	Junction Box
2	Alarm input/output	8	Sealing Plugs
3	Audio input/output	9	Lens
4	Network Interface (PoE)	10	Reset Button
5	Power Interface (12 VDC)	11	Memory Card Slot
6	Video Out (BNC)	12	Grounding screw

Note:

Press RESET about 10s when the camera is powering on or rebooting to restore the default settings, including the user name, password, IP address, port No., etc.

2 Installation

Before you start:

- Make sure the device in the package is in good condition and all the assembly parts are included.
- The standard power supply is 12 VDC or PoE (802.3 af), please make sure your power supply matches with your camera.
- Make sure all the related equipment is powered off during installation.
- Make sure that the wall is strong enough to withstand four times the weight of the camera and the bracket (if applicable).

Pay attention to the following precautions to prevent IR reflection:

- Dust or grease on the dome cover will cause IR reflection. Please do not remove the dome cover film until the installation is finished. If there is dust or grease on the dome cover, clean the dome cover with clean soft cloth and isopropyl alcohol.
- Make sure that there is no reflective surface too close to the camera lens. The IR light from the camera may reflect back into the lens causing reflection.
- The foam ring around the lens must be seated flush against the inner surface of the bubble to isolate the lens from the IR LEDs. Fasten the dome cover to camera body so that the foam ring and the dome cover are attached seamlessly.

2.1 Memory Card Installation

Steps:

1. Unscrew the memory card slot cover.

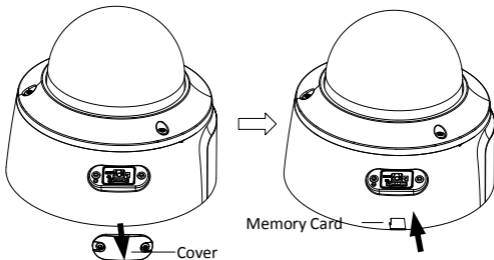

Figure 2-1 Install Memory Card

2. Insert the memory card into the memory card slot, and push to fully seat.
3. (Optional) To unmount the memory card, push to eject it.
4. Reinstall the memory card slot cover.

2.2 Mounting Preparation

Steps:

1. Lift the camera body to separate it from the junction box.
2. Loosen the adapter plate screws, and remove the mounting plate from the junction box.

3. Unscrew the bubble.

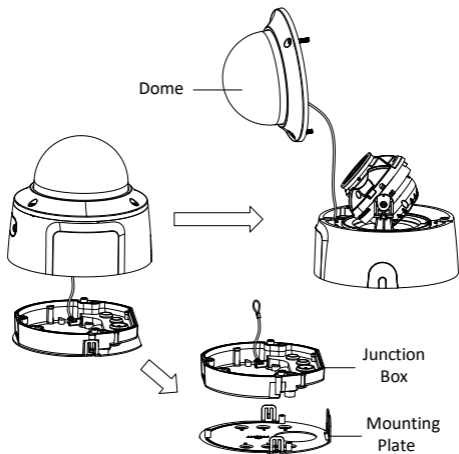

Figure 2-2 Disassemble the Camera

2.3 Camera Mounting

2.3.1 Ceiling Mounting

Before you start:

Plan the cable routing before installation.

This camera supports cable-routing through the ceiling and through the side outlet of the camera.

- If routing through the ceiling, cut a hole in ceiling according to the mounting and route the cables in advance.
- If routing through the side outlet, you may choose to route cables with or without conduit.

Steps:

1. Place the mounting adapter at the desired location and mark 4 screw according to the holes marked (2) on the mounting plate.

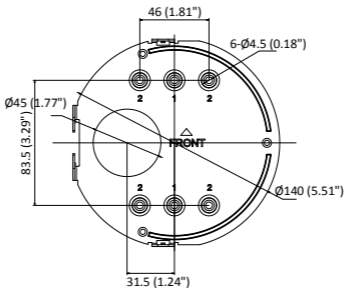

Figure 2-3 Mounting Plate

2. (Skip if not needed) Route cables through conduit.
 - 1). Screw the supplied conduit joint to the conduit.

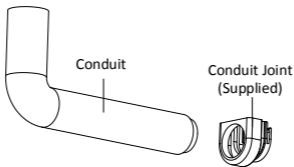

Figure 2-4 Connect the Conduit Joint to Conduit

- 2). Fit the mounting plate over the the conduit joint using the tabs as a guide.

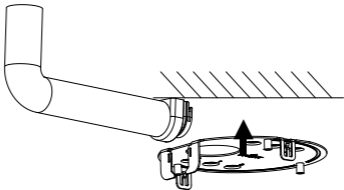

Figure 2-5 Install the Conduit

3. Secure the mounting plate to the ceiling with the four supplied screws.

Note:

Use plastic anchors for installation against a cement surface, and self-tapping screws for installation against a wood surface.

4. Route the cables through the junction box.
 - 1). Pierce the sealing plugs on the junction box.

2). Thread cables through the sealing plugs.

Note:

For RJ45-terminated cables, use the supplied cable routing tool.

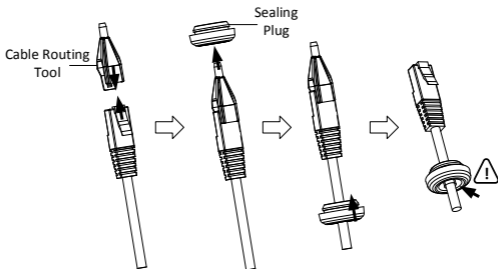

Figure 2-6 Route RJ45-terminated cable through Sealing Plug

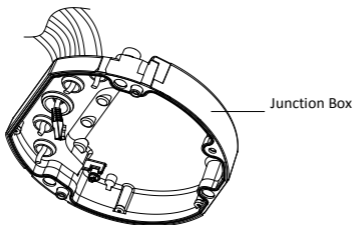

Figure 2-7 Route Cables through Junction Box

5. Align the “FRONT” marks on junction box and mounting plate, then secure the junction box to the mounting plate.

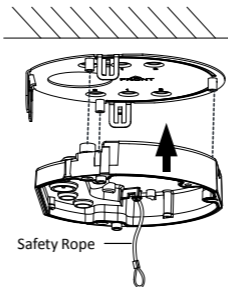

Figure 2-8 Install Junction Box

6. Hang the camera body on the safety rope.
7. Connect the cables to corresponding ports on the camera.

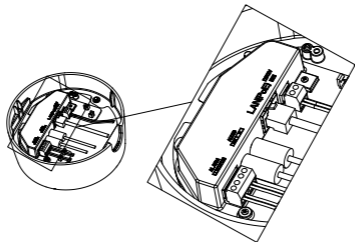

Figure 2-9 Connect Cables

8. Affix the camera body to the junction box.

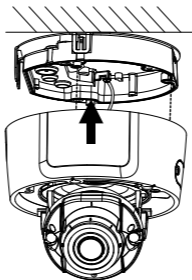

Figure 2-10 Affix the Camera Body

9. Adjust the viewing angle of the camera (aim).

- 1). Use supplied BNC video out cable to connect the camera to a monitor. Power on the camera to obtain live image of the camera.

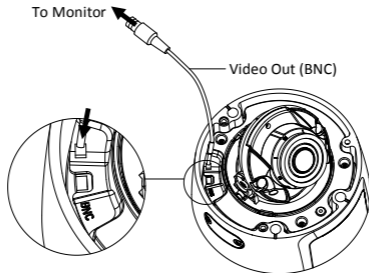

Figure 2-11 Connect Video Out

- 2). Hold the lens to adjust the panning, tilting, and rotating position.

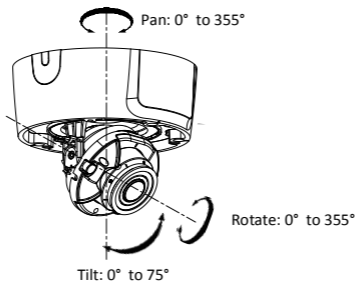

Figure 2-12 Adjust Viewing Angle

10. Peel off the protective films and reinstall the dome to the camera body.

This camera supports mounting with wall mounting brackets, and pendant mounting brackets.

2.3.2 Wall Mounting

The wall mounting bracket is not included in the package. **Note:** When choosing a wall mounting bracket, the cap must match the mounting plate of the camera. See Figure 2-3.

Steps:

1. Route the cables and install the wall mounting bracket.
2. Install the cap to the bracket. Secure the cap with the set screw.

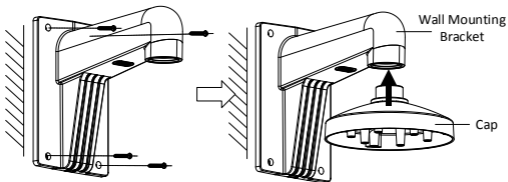

Figure 2-13 Install Wall Mounting Bracket

3. Align the screw holes of the mounting plate with the corresponding screw holes of the cap.

4. Route the cables through the cable hole on the mounting plate and secure the mounting plate to the cap.

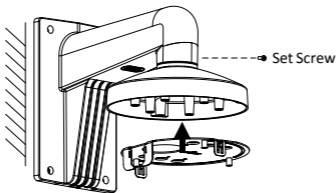

Figure 2-14 Install Mounting Plate to Bracket Cap

5. Repeat step 4 to step 10 of *Section 2.3.1 Ceiling Mounting* to complete camera installation.

2.3.3 Pendant Mounting

The pendant mounting bracket is not included in the package.

Note:

When choosing a pendant mounting bracket, the cap must match the mounting plate of the camera. See Figure 2-3.

Steps:

1. Route the cables and install the pendant mounting bracket.
2. Install the cap to the bracket. Secure the cap with the set screw.

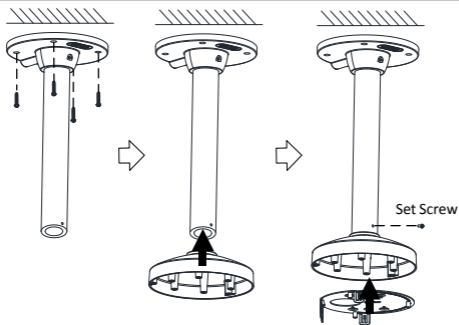

Figure 2-15 Install the Pendant Mounting Bracket

3. Align the screw holes of the mounting plate with the corresponding screw holes of the cap.
4. Route the cables through the cable hole in the mounting plate and secure the mounting plate to the cap.
5. Repeat step 4 to step 10 of *Section 2.3.1 Ceiling Mounting* to complete camera installation.

3 Configuring the Camera over the LAN

Note:

By using this product, you acknowledge that the use of the product with Internet access might present network security risks. For avoidance of any network attacks and information leakage, please strengthen your network protection.

If the product does not work properly, contact your dealer or the nearest service center for help.

3.1 Wiring

Connect the camera to network according to the following figures.

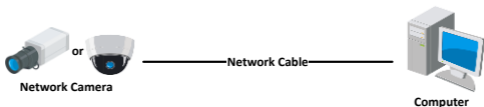

Figure 3-1 Connecting Directly

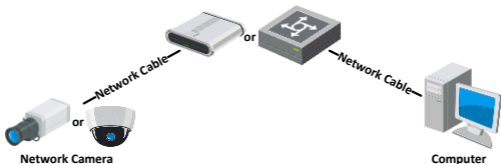

Figure 3-2 Connecting via a Switch or a Router

3.2 Activating the Camera

You are required to activate the camera first by setting a strong password for it before you can use the camera.

Activation via Web Browser, activation via SADP, and activation via Client Software are all supported. Activation via SADP software and activation via web browser will be shown as examples to illustrate camera activation.

3.2.1 Activation via Web Browser

1. Power on the camera. Connect the camera to your computer or the switch/router which your computer is connected to.
2. Input the IP address of the camera into the address bar of the web browser, and press Enter to enter the activation interface.

Notes:

- The default IP address of the camera is 192.168.1.64.
- The computer and the camera should belong to the same subnet.

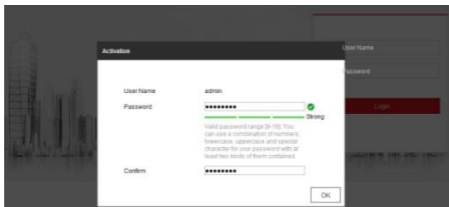

Figure 3-3 Activation Interface(Web)

3. Create a password and input the password into the password field.



STRONG PASSWORD RECOMMENDED– *We highly recommend you create a strong password of your own choosing (using a minimum of 8 characters, including upper case letters, lower case letters, numbers, and special characters) in order to increase the security of your product. We recommend you reset your password regularly, especially in high security systems, resetting the password monthly or weekly can better protect your product.*

4. Confirm the password.
5. Click **OK** to save the password and enter the live view interface.

3.2.2 Activation via SADP Software

SADP software is used for detecting cameras on the network, activating cameras, and resetting camera passwords.

Obtain the SADP software from the supplied disk or the official website, and install SADP according to the prompts.

1. Run the SADP software to search for cameras on the LAN.
2. Select the inactive camera in the device list.

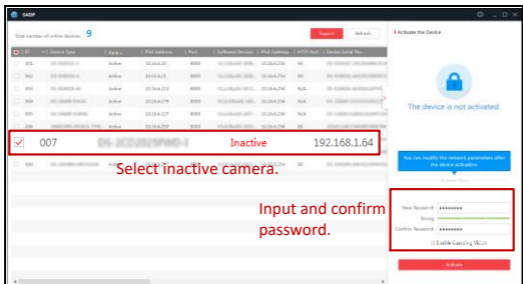

Figure 3-4 SADP Interface

Note:

The SADP software supports batch activation.

3. Create and input the new password in the password field, and confirm the password.



STRONG PASSWORD RECOMMENDED– *We highly recommend you create a strong password of your own choosing (using a minimum of 8 characters, including upper case letters, lower case letters, numbers, and special characters) in order to increase the security of your product. We recommend you reset your password regularly, especially in high security systems, resetting the password monthly or weekly can better protect your product.*

Note:

You can enable the STGO2 service for the device during activation. Refer to Chapter 5.1 for detailed information.

4. Click **Activate** to finish activation.

You can check whether the activation was successful in the popup window. If activation fails, make sure that the password meets the minimum requirements and try again.

3.3 Modifying the IP Address

To view and configure the camera via LAN (Local Area Network), you need to address the network camera to the same subnet as your PC.

Use the SADP software or client software to detect the camera and change the its IP address. IP Address modification via SADP is shown below.

Steps:

1. Run the SADP software.
2. Select an activated camera.
3. Change the device IP address to the same subnet as your computer by either modifying the IP address manually or checking the Enable DHCP checkbox.

Modify Network Parameters

Enable DHCP
 Enable Guarding Vision

Device Serial No.:

IP Address:

Port:

Subnet Mask:

Gateway:

IPv6 Address:

IPv6 Gateway:

IPv6 Prefix Length:

HTTP Port:

Security Verification

Admin Password:

[Forgot Password](#)

Figure 3-5 Modify the IP Address

Note:

You can enable the STGO2 service for the device during activation. Refer to Chapter 5.1 for detailed information.

4. Input the admin password and click **Modify** to save IP address modification.

Batch IP address modification is supported by the SADP software.

4 Accessing via Web Browser

System Requirement:

Operating System: Microsoft Windows XP SP1 and above

CPU: 2.0 GHz or higher

RAM: 1G or higher

Display: 1024×768 resolution or higher

Web Browser: Internet Explorer v8.0 and above, and Google

Chrome v18 and above (via IE Tab).

Steps:

1. Open the web browser.
2. In the browser address bar, input the IP address of the camera, and press the **Enter** key to enter the login interface. **Note:**
 - The default IP address is 192.168.1.64.
3. Input the user name and password.

The admin user should configure the device accounts and user/operator permissions properly. Delete any unnecessary accounts and user/operator permissions.

Note:

The device will become locked if the admin account performs 7 failed password attempts (5 attempts for user/operator accounts), and must be power-cycled before use can resume.

4. Click **Login**.



Figure 4-1 Login Interface

5. Install the plug-in before viewing the live video and managing the camera. Please follow the installation prompts to install the plug-in.

Note:

You may have to close the web browser to finish the installation of the plug-in.

[Please click here to download and install the plug-in. Close the browser when installing the plug-in.](#)

Figure 4-2 Download Plug-in

6. Reopen the web browser after the installation of the plug-in and repeat steps 2 to 4 to login.

Note:

For detailed instructions of further configuration, please refer to the user manual of network camera.

5 Operating via STGO2 App

Purpose:

STGO2 is an application for mobile devices. With the app, you can view the live stream of the camera, receive alarm notifications and so on.

5.1 Enable STGO2 Service on Camera

Purpose:

The STGO2 service should be enabled on your camera before using the service.

You can enable the service through SADP software or web browser.

5.1.1 Enable STGO2 Service via SADP Software

Steps:

1. Check the checkbox of **Enable STGO2** on:
 - 1). "Activate the Device" page during camera activation (refer to Chapter 3.2.2)
 - 2). Or "Modify Network Parameters" page while modifying IP address, refer to Chapter 3.3.
2. Create and enter a verification code. Enter again to confirm.

Tips [X]

To enable Guarding Vision service, you need to create a verification code or edit the verification code.

Verification Code

6 to 12 letters or numbers, case sensitive. You are recommended to use a combination of no less than 8 letters or numbers.

Confirm Verification Code

The Guarding Vision service will require internet access. Please read the [Service](#) and [Privacy Policy](#) before enabling the service.

Confirm

Figure 5-1 Verification Code Setting (SADP)

Note:

The verification code is required when you add the camera to the STGO2 app.

3. Click and read the "Terms of Service" and "Privacy Policy".
4. Confirm and save the settings.

5.1.2 Enable STGO2 Service via Web Browser

Before you start:

You need to activate the camera before enabling the service. Refer to Chapter 3.2.

Steps:

1. Access the camera through a web browser. (Refer to Chapter 4)
2. Enter the platform access configuration interface: Configuration > Network > Advanced Settings > Platform Access

Enable
 Platform Access Mode:
 Server IP: Custom
 Register Status:
 Verification Code:

6 to 12 letters (a to z, A to Z) or numbers (0 to 9), case sensitive. You are recommended to use a combination of

Save

Figure 5-2 Platform Access Configuration (Web)

3. Select Platform Access Mode as STGO2.
4. Check the Enable checkbox.
5. Click and read the "Terms of Service" and "Privacy Policy" in the pop-up window.
6. Create and enter a verification code. Enter again to confirm.

Note:

The verification code is required when you add the camera to the STGO2 app.

7. Confirm and save the settings.

5.2 STGO2 Setup

Steps:

1. Download and install the STGO2 app by searching “STGO2” in the App Store (iOS) or Google Play™ (Android).
2. Launch the app and register for a STGO2 user account.
3. Log into the STGO2 app after registration.

5.3 Adding the Camera to STGO2

Before you start:

You need to enable the STGO2 service on the camera before adding it to your STGO2 account. Refer to Chapter 5.1.

Steps:

1. Use a network cable to connect the camera to a router.



Figure 5-3 Connect a Router

Note:

After the camera connects to the network, please wait one minute before any operation on the camera using the STGO2 app.

2. In the STGO2 app, tap “+” on the upper-right corner and then scan the QR code of the camera to add the camera.

You can find the QR code on the camera or on the camera packaging.

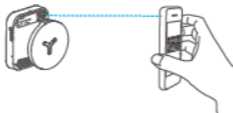



Figure 5-4 Scan QR Code

Note:

If the QR code is missing or too blurry to be recognized, you can also add the camera by tapping the  icon and inputting the camera's serial number.

3. Input the verification code of your camera.

Note:

- The required verification code is the code you create or change when enabling STGO2 service on the camera.
 - If you forget the verification code, you can check the current verification code on the **Platform Access** configuration page via a web browser.
4. Follow the prompts to set the connection and add the camera to your STGO2 account.

Note:

For detailed information, refer to the user manual of the STGO2 app.

5.4 Initializing the Memory Card

Steps:

Check the memory card status by clicking on "Storage Status" in the "Device Settings" interface.

If the memory card status displays as "Uninitialized," click to initialize it. The status will then change to Normal. You can then start recording any event triggered video in the camera such as motion detection.